

# ***dynaco*** **AF-6**

SERIAL NUMBER

This number must be mentioned in all communications concerning this equipment.

## **INSTRUCTIONS FOR ASSEMBLY OPERATION**



***dynaco inc.***

COLES ROAD & CAMDEN AVENUE / POST OFFICE BOX 88  
BLACKWOOD, N. J. 08012, U.S.A.

Bob01605@aol.com

## CONTENTS

Installation and Operating Instructions .....	4
Circuit Description .....	7
Getting the Most from your Tuner .....	8
Operation Outside the United States .....	9
Assembly Instructions .....	9
Schematic Diagram .....	16/17
Parts List for Schematic Diagram .....	18/19
AM Alignment without Instruments .....	25
Professional Service Alignment .....	26
Factory Service and Warranty .....	28
Kit Parts List .....	29
Circuit Board Diagrams & Voltage Test Points .....	30/31
Pictorial Diagram .....	Insert
Diagram of 240 Volt Connections .....	Insert
Diagram of 120 Volt Connections for Canada .....	Insert

## FM SPECIFICATIONS

**IHF sensitivity (noise and distortion down 30 dB @ 100% modulation):** 1.75  $\mu$ V.

**Input required for 40 dB S/N @ 100% modulation:** 2.0  $\mu$ V.

**Input required for 50 dB S/N @ 100% modulation:** 5.0  $\mu$ V.

**Frequency response before de-emphasis:** 20 Hz to 52 kHz,  $\pm$ 1 dB.

**De-emphasis time-constant:** 75  $\mu$ sec.

**Frequency Response:** 20 Hz to 15 kHz  $\pm$  1 dB

**Harmonic distortion and IM distortion @ 100% modulation:**

Mono—0.5% (0.25% typical).

Stereo—0.9% (0.5% typical).

**Capture ratio:** 1.5 dB.

**Muting threshold:** 4  $\mu$ V.

**Output @ 100% modulation:** 2 volts.

**Ultimate signal to noise ratio:** 65 dB @ 100% modulation.

**Drift:** less than 0.02%.

**Selectivity:** 65 dB alternate channel.

**AM suppression:** 58 dB.

**Stereo switching threshold:** 4  $\mu$ V.

**Stereo separation:** @ 1000 Hz, 40 dB.

@ 50 Hz, 30 dB.

@ 10 kHz, 30 dB.

**19 kHz and 38 kHz subcarrier suppression:** 50 dB minimum

**67 kHz SCA carrier suppression:** 80 dB minimum.

## AM SPECIFICATIONS

**Sensitivity:** 50 microvolts with external input.

**Selectivity:** 20 dB @ 10 kHz.

55 dB @ 20 kHz.

**Image Rejection:** 60 dB.

**Total Harmonic Distortion:** less than 2%.

**IF Rejection:** 70 dB @ 1000 kHz.

**Antenna Provisions:** 300 ohm balanced and 72 ohm unbalanced external FM inputs; built-in AM ferrite loopstick; external AM input and ground connection.

**Control Provisions:** Power/Volume; Tuning; AM/FM switch; FM Tuning switch (mute off/muting/muting with Dynatune™); mode switch (mono/stereo filter/stereo FM, or narrow/ medium/wide AM bandwidth).

**Dimensions:** 13½" x 12" x 4¼" High.

**Shipping weight:** 13 lbs.

**Power consumption:** 12 watts, 120V or 240V, 50/60 Hz AC.

# THE AF-6 DYNATUNER

## INTRODUCTION

The Dynaco AF-6 is the culmination of years of Dynaco design research directed towards the goal of exemplary performance under a wide range of reception conditions, with the high reproducibility which assures consistent results from kit-built units, all at modest cost. It provides a generous layout for easy assembly and outstanding serviceability.

The primary consideration in the development of each new Dynaco product is exceptional performance. The AF-6 delivers this in full measure. The design considerations necessary to achieve a premium quality kit lead automatically to a distinctly superior factory assembled unit as well.

A tuner can only process the signal picked up by its antenna, however. The proper design FM antenna for your receiving conditions is thus a vital adjunct to your music system. A section of this manual gives some suggestions in this regard, but competent local advice which takes into account your particular location will always be advantageous. As a rule, once a good-quality tuner has been chosen, additional investment in a better antenna system yields several times greater reception benefits than the same money spent on a more costly tuner.

The determination of the best FM tuner design for maximum listening enjoyment is not one which can be made entirely in the laboratory, nor can it be fully defined by specifications. Extensive field testing is a vital part of tuner design. Reception conditions vary so widely that certain tuner characteristics which favor reception in some instances may prove a handicap under different circumstances. Side-by-side listening comparisons of the AF-6 with FM tuners several times its cost demonstrate the AF-6's ability to reject the pervasive effects of multipath dispersion on strong urban signals, as well as to clearly receive weak or distant signals without noise or interference.

Because FM systems are inherently capable of superior audio performance, AM tuners have rarely been seriously evaluated from the high fidelity point of view. AM signals are so subject to local interference that even component tuners restrict their bandwidth to substantially less than the best broadcast signals, in the interest of maintaining low noise. To obtain better selectivity (isolation from other broadcast signals of nearly the same frequency) and good intelligibility, most AM tuners start to roll off the high frequencies above 1000 Hz. Typical response is usually down more than 10 dB at 5 kHz sloping off steadily from 1000 Hz, or less. Since most broadcast signals are not so limited, Dynaco engineers looked for a way which would preserve selectivity and yet provide extended audio range. The result is a unique audio bandwidth switch which in the "wide" position preserves smooth response to 5 kHz, where it is down only 5 dB. (If this does not sound very "hi-fi" just listen to the difference!) The "medium" or normal position is down 15 dB. The "narrow" setting rolls off to 22 dB down at 5 kHz and has measurably higher sensitivity. Coupled with low distortion, high sensitivity and outstanding AGC characteristic, the result is far more listenable signals in heavy interference conditions, and unexpectedly accurate reproduction of high quality signals.

Atmospheric conditions frequently make it possible to receive AM transmissions over very long distances; numerous stations crowd the AM band in many localities; and overmodulation is a common broadcasting fault. Thus good clean reception demands a very high order of selectivity, or separation of the desired signal channel from those on either side. The AF-6 uses a costly 12 section LC design IF filter, for exceptional selectivity at even 10 kHz, and it achieves 55 dB at 20 kHz. A separate 40 dB audio notch filter at 10 kHz reduces off-channel interference effects.

Vanishingly low distortion has always been a hallmark in any product bearing the Dynaco name. On AM, a distortion measurement below 2% with signals between 50 $\mu$ v and 100,000  $\mu$ v is superlative. The FM section, like the FM-5, establishes new low distortion standards, not only for the conventional measurement of in-phase L+R signals, but more importantly, for left and right signals of dissimilar phase (which carry the extra dimensional information in matrixed 4-D broadcasts) and for independent left and right signals (which is usually the worst case). Dynaco tuners typically stay below 0.5% in all modes, but IHF distortion specs call only for measuring the mono (L+R) mode, which is often much lower in some designs. Coupled with outstanding phase integrity in a solid state tuner, this yields exemplary separation with any of the matrix-type 4-Dimensional (oftentimes incorrectly called 4-Channel) broadcasting systems now proposed, including the ingeniously simple DYNAQUAD™ system developed by Dynaco.

Any truly successful high performance audio kit design must also deliver unchanging results over extended use. This also implies assurance that the standards set by the factory assembled units are consistently reproducible when even a novice properly assembles the kit. The more than 15 year old Dynaco reputation for consistently meeting conservative, detailed specifications is your best guarantee that the AF-6 will do just that. The three fiberglass etched circuit boards and the front end assembly (which contain all of the active circuitry) have been completely tested and aligned as a matched set for the kit, leaving nothing but their interconnection for the builder. The excellent specifications of the AF-6 are possible, and guaranteeable, unit to unit, lab model to production kit, because of the extraordinary uniformity which etched circuits provide, and the inherent stability of the circuit configuration.

The capability for the finest FM performance is of little value if it cannot be readily utilized in normal use. The consummate FM tuning ease of the AF-6 is a case in point. You simply take your hand off the tuning knob as soon as the TUNED indicator is illuminated. The exclusive DYNATUNE™ circuit *automatically* fine-tunes the station. A stereo broadcast will *automatically* switch the tuner to stereo reception, and light the STEREO indicator too.

The AF-6 actually exceeds its own IHF specifications when it comes to listenable results. The IHF procedure for determining the distortion specification of a tuner allows readjustment of the source signal for the lowest measurable distortion. You the listener cannot do this. In the past you have had to rely on the uncertainty of "center of channel"

meter systems, or on the even less precise signal strength maxima indications. The certainty of the DYNATUNE™ circuit automatically eliminates these variables, assuring reception with the lowest possible distortion. The DYNATUNE™ logic circuit senses the presence of the desired signal, together with the absence of noise, before it will switch on the audio. Then it *automatically* fine-tunes to the exact center of the FM channel (the minimum distortion point) in either mono or stereo. Such precise tuning is accomplished faster and more accurately than *any* other tuning system.

A clearly audible virtue of this design is the total elimination of switching transients in the operation of the muting function. And you have the convenience of interstation muting down to the levels of the weakest useable signals—in the vicinity of 4 microvolts! The result is absolute silence—or the station in correct tune. Only Dynatuners achieve this ultimate goal. This refined muting circuit eliminates the possibility of damaging speakers or solid state amplifiers as a result of the low frequency “thumps” so common in the past with rapid dial manipulation. Yet so sophisticated is its operation that selectivity of adjacent channels is completely unaffected.

In urban locations where the AF-6's extreme FM sensitivity could have been a handicap, special care was taken in the design of the front end to accommodate extremely powerful signals without encroaching on adjacent weaker channels. The AF-6's suppression of spurious responses (cross-modulation) is notable among solid state tuners. Generous tolerance of overmodulation (an all-too-common broadcasting fault) yields low distortion signals in instances where others suffer.

Smooth flywheel action, a long uniformly spaced dial, and the most accessible and easiest to install dial stringing system ever, make the FM-5 a joy to use, and a breeze to construct. Only those who have built other tuners with similar dials can fully appreciate the latter.

The FM-IF section utilizes two 4-pole ceramic filters for the optimum combination of alignment accuracy and stability, phase integrity and effective selectivity. The ideal selectivity curve is a 3-sided rectangle—unachievable in practice. Of the several approaches to this goal, the compromises in each must be weighed in the light of other criteria. The AF-6 demands an unusually high degree of alignment accuracy and stability to assure that prealigned circuit boards conform in all respects to a fully assembled unit when it has been aligned on completion. Too, the advent of DYNAQUAD™ and other similar matrix-type 4-Dimensional broadcasts demands an unusually high degree of phase linearity for maximum separation and low distortion reproduction. Such characteristics also lead naturally to better reception of even conventional stereo broadcasts. These goals tend to conflict with design criteria

which favor the achievement of the most impressive figures for selectivity specifications. Indeed, some of the quoted selectivity figures are of dubious validity. Impressive figures can be obtained if phase linearity is ignored. Beyond a certain point the antenna becomes a much more significant factor where adjacent channel signals are possible, and alternate channel isolation is important.

FM Sensitivity—the most quoted tuner specification—is in fact of minimal concern for most users. The AF-6's specification of 1.75 microvolts closely approaches the accepted theoretical limit of signal strength, and yet retains great stability, notable spurious response rejection, and excellent AM (multipath) rejection. The steep limiting curve exemplified by the 50 db signal to noise ratio with only a 5 microvolt signal is of far greater significance than the IHF sensitivity. A signal should have a signal to noise ratio of at least 40 db (which occurs at only 2 microvolts) to be of acceptable listening quality. At normal signal levels, the typical signal to noise figure is 65 db!

Exceptional filtering of the 19 kHz multiplex pilot carrier, the 38 kHz multiplex subcarrier, and of 67 kHz SCA subcarriers assure freedom from interference beats with tape recorder oscillators when recording off the air. Additional 67 kHz filtering, with phase correction, was found to yield better reception of weak noisy signals, and thus Dynatuners afford 80 db or more rejection at this frequency.

More than with any other audio product, FM tuner specifications need to be evaluated with a somewhat jaundiced eye, and an appreciation that individually impressive figures do not necessarily yield the best listening results in the real world. Foremost is the limitation that most tuners are designed to meet criteria established by measurements made in a specially shielded room. Such results are not necessarily transposable to your living room. Neither the tube type FM-3 Dynatuner nor the AF-6 were based on shielded room evaluations. The FM-3 established an enviable reputation for outperforming numerous tuners of far greater cost having apparently better specifications on paper.

The AF-6 is a break with the kit design philosophy of the FM-3 predecessor. The FM-3 was designed from the ground up to be wholly self-aligned by the builder on completion. Because of that recognized success, Dynaco thoroughly pursued over many months the possibility of a similar design using transistors. The characteristics of solid state devices preclude this approach. Thus the AF-6 evolved as a concept of highly stable performance which could be honed to perfection when factory aligned as a set of 4 matched subassemblies, capable of being tested as a fully operational tuner. Thus no adjustment of any nature should be made short of *complete* alignment facilities. Solid state reliability makes such adjustment unlikely for the life of the tuner.

## INSTALLATION AND OPERATING INSTRUCTIONS

The highly refined and distilled engineering of the AF-6 combines the performance of far more costly and complex FM stereo tuners with an AM section of unusually high audio quality and operating ease and simplicity. Exhaustive engineering research has supplanted many adjustments, controls and indicators with automated operation, freeing the listener to sit back and enjoy the results.

Normal FM operation leaves all 3 switches depressed to the right. Once the power/volume control is rotated to the desired volume level, you need only turn the dial until the FM TUNED indicator is illuminated at the desired station. It is as simple as that. Switch to AM, and the maximum meter indication is the correct tuning point.

## AC Line Connection

The AF-6 is normally wired for the U.S. standard 120 volt, 60 Hz AC line. Alternative wiring to accommodate 240 volt operation, at either 50 or 60 Hz, is described later in this manual. Typically the tuner will be plugged into a switched outlet on the control center or amplifier. Then the tuner's power switch may be left "on" at the volume setting which matches other program sources. The AC outlet on the back panel of the AF-6 is controlled by the front panel switch. Thus if no separate control center is needed in your system, the power amplifier may be switched through this outlet, and the AF-6 plugged into a wall outlet.

## Antenna Connections

Four screw terminals are provided on the back panel for external AM and FM antennas. A twinlead folded dipole FM antenna is supplied with the tuner, which will be adequate for most locations. It should be connected to the two screw terminals nearest the line cord. Suggestions on FM antenna applications will be found in a later section of this manual, entitled "Getting The Most From Your FM Tuner." Other FM antennas using the same type of flat wire lead-in are also 300 ohm systems, and are connected to the same terminals. Shielded 300 ohm lead-in (3 wires) connects the shield to the (second) GND terminal, and the signal leads to the right hand terminals.

Shielded coaxial cable used in many distribution systems provides a 72 ohm unbalanced lead-in. It may be directly connected without a matching balun transformer. The shield connects to the GND terminal, and the center conductor to the adjacent screw terminal on the right.

The high efficiency ferrite loopstick AM antenna mounted on the back panel will suffice in all but the most critical situations. Its pickup capability can be limited by nearby metal surfaces, so it is important that the antenna bracket be swiveled outwards so that it is at right angles to the panel. Then swing the tubular antenna to the position which provides the quietest signal. The best AM antenna orientation is determined by the *quality*, not the strength of the signal. Because AM reception is so susceptible to local interference sources (which electrically resemble the desired broadcast signal), and the wide frequency response of the AF-6 can make such noise effects very apparent, proper positioning of the antenna for lowest noise is most important.

Interference may be transmitted by the AC power line, or it may be radiated by appliances, oil burners, fluorescent lights, lamp dimmers, etc. The radiated effects can be minimized by antenna placement. In special circumstances, as when the tuner is mounted face up in a cabinet, the usual adjustment is limited. Thus an extra hole is provided in the back panel which enables the antenna bracket to be mounted alternatively at right angles to the cover.

Where optimum AM reception is important, an external long wire AM pickup which is carefully insulated from ground should be connected to the left screw terminal, and it is used in conjunction with the loopstick. A separate earth ground should then be connected to the GND terminal.

## Output Connections

A pair of shielded cables is supplied with the AF-6. These should be connected from the AUDIO OUT tuner sockets to the FM-MPX, RADIO or TUNER inputs of the control

center or amplifier. The output level of the AF-6 is adjusted by the front panel volume control. The nominal output level at maximum rotation from a fully modulated signal is 2 volts at 1000 ohms output impedance. Thus you can also connect the tuner directly to any basic power amplifier which has an input sensitivity of less than 2 volts for full output.

The output level of the TAPE OUT sockets is also adjusted by the volume control. These may be connected to the line inputs of a tape recorder.

## Off / Volume Control

The power switch, which also controls the back panel AC outlet, is a part of the volume control. If the tuner is plugged into a switched AC outlet on the control center, the tuner's volume control will likely be left in the upper half of its range, where the tuner level will match the level of other inputs to the control amplifier.

## Mono / Stereo / AM Bandwidth Switch

FM functions are identified above the switch. The normal switch position is depressed to the right. The tuner switches FM automatically from mono to stereo operation, and lights the STEREO indicator whenever the tuned station is broadcasting the 19 kHz multiplex stereo pilot carrier signal.

In the middle STEREO FILTER position, high frequency separation of stereo broadcasts is reduced, or blended, and the high frequency response is rolled off 4 db @ 10 kHz to improve the signal-to-noise ratio on weak stereo signals. In other respects tuner operation is similar to the normal STEREO mode.

In the MONO position all stations will be heard monophonically and the stereo indicator will never light. This position may provide greater clarity in monophonic reception of *very* weak stereo broadcasts.

Without the stereo pilot carrier, the tuner reverts to mono operation automatically. However, stereo tuner characteristics dictate that lower noise will be obtained in the MONO switch position.

AM audio bandwidths are indicated below the switch. The normal position is the *middle* MEDIUM setting, which is similar to most other tuners in audio quality.

The WIDE position extends the audio range, and will result in notably more accurate reproduction where the signal quality and freedom from interference warrants it. However, a strong signal does not necessarily justify the WIDE position for best listening. Noise or unfavorable broadcast quality may contribute to less pleasant sound in this mode. Some AM signals are handicapped by high frequency boost or excessive distortion.

The NARROW position sharply attenuates the high frequency response for satisfactory reception in high interference conditions.

You should not be surprised if local conditions make it impractical to use the WIDE position, for nearby wiring, appliances and mechanical devices, as well as atmospheric conditions, can all have adverse interference effects. Relocation to avoid fluorescent lamps, light dimmers, etc., installation of line interference filters (usually most effective at the offending appliance), or a good external antenna and ground connection may prove beneficial where the best AM reception is important.

## AM / FM Switch

This selects either AM or FM programming. AM reception is always monophonic.

## Dynatune Switch

Muting of interstation noise and DYNATUNE™ automatic tuning circuitry function only on FM reception. If you wish to defeat the muting action, you cannot use DYNATUNE™, for the two circuits are interrelated.

In the OFF position the muting circuitry and the automatic DYNATUNE™ circuitry is defeated. This permits extremely weak signals to be perceived, as there is no interstation noise suppression (muting). Tune for maximum vertical meter indication. The TUNED light will flicker on very weak signals of varying strength. For the reception of such signals it is best to operate in the MONO mode.

The middle switch position is preferred for normal operation with the highest tuning accuracy. The muting circuit eliminates all interstation noise. When the TUNED light comes on, let go of the tuning knob and switch to the extreme right DYNATUNE™ position. The automatic circuitry will then take over for precise tuning of the center of the channel for minimum distortion.

You may prefer to leave this switch in the DYNATUNE™ position most of the time, as this is the easiest method of operation. The proper tuning procedure here is to release the tuning knob as soon as the TUNED light indicates the desired station. "Fiddling" back and forth on the dial is not recommended with the switch in this position, for it may leave it on the "edge" of the correct zone. In such a case the automatic tuning circuitry may not be able to fully correct for lowest distortion reception.

## Signal Strength Meter

The meter facilitates accurate tuning of AM stations, where you seek the highest meter indication. The AM section is so sensitive, and the AGC action so effective, that it is possible to receive fair quality signals that are below the meter sensitivity threshold. The meter should *not* be used to determine to best position for the AM loopstick antenna, however, unless the lowest noise happens to coincide with the strongest signal indication.

On FM, such meters are insufficiently precise to be of any real aid in critical tuning, but they can be of significant value in determining the best FM antenna orientation. The FM meter circuit of the AF-6 has been compensated to accurately show changes in signal strength at a very few microvolts, as well as those inordinately powerful signals above 10,000 microvolts. In the latter case, with the meter at its maximum, it is best to switch an attenuator in the antenna leadin to obtain the best reception.

The operation of this meter circuit is such that normal signal levels will all indicate very similar levels near the center of the meter scale, even though they may vary over a wide range. Such signals do not normally present reception problems, and the meter is then unnecessary. Its circuit has been designed to be most meaningful when it can be most useful.

While a maximum meter indication will show the proper tuning zone, well within the DYNATUNE™ "window", it is possible that a minute reduction from the maximum meter indication may be observed as the DYNATUNE™ circuit takes

over on signals strong enough to activate it, and the muting circuit. The DYNATUNE™ circuit enables far greater tuning precision than manual tuning with *any* meter system.

## The FM Tuned and Stereo Indicator Lights

The FM TUNED indicator lights when you are on an FM station. If the station is broadcasting in multiplex stereo, the STEREO light will also come on an instant later.

As the tuning dial approaches within 80 kHz of the station's broadcast frequency, the illumination of the TUNED light will indicate that the DYNATUNE™ circuit can take over. This will "lock on" that signal for the next 250 kHz. If the station is approached from the opposite direction, the same locking action will be observed in the reverse direction, starting again within 80 kHz of the broadcast frequency.

If the dial location is more than 80 kHz distant from the broadcast frequency, and the DYNATUNE™ switch is disengaged, the signal will be muted. To resume reception, the tuner will have to be re-tuned until the TUNED light is again illuminated.

Occasional lack of stereo separation when the STEREO indicator is lighted is possible if the station neglected to turn off its 19 kHz stereo pilot when broadcasting mono.

If either of these two lights flicker, it indicates exceedingly low signal strength (below 4 microvolts) or noise interference spikes of very high intensity. In such a case readjustment of the antenna for a better signal may be possible. Switching the muting switch "Off" may also prove useful.

## Tuning an FM Station

The DYNATUNE™ circuit operates simultaneously with the muting circuit. If you wish to defeat muting, you cannot use DYNATUNE™. While this circuit "locks in" a station well past the exact frequency as the tuning traverses the dial, selectivity between closely spaced stations is not impaired, and the second station can be tuned easily from the opposite direction.

The simplest tuning procedure is to move the dial deliberately, and release it as soon as the TUNED indicator lights. Allow DYNATUNE™ to do the rest. If you move the dial rapidly, you will hear no sound, and the indicator will not light at all.

## Installing Your AF-6

Your AF-6 generates very little heat. It is unnecessary to provide ventilation, even with continuous duty operation. The AF-6 may be mounted in any position, and if desired, other units may be stacked on top of it.

Your dealer can supply walnut finish cabinets for either the AF-6 alone, or double cabinets which accommodate Dynaco preamplifiers or control amplifiers as well. An accessory rack mounting kit is also available.

For panel mounting, an accessory PBK bracket kit is available from Dynaco for \$3 postpaid. No CODs please. A single rectangular cutout 13" by 3<sup>13</sup>/<sub>16</sub>" is required in any panel up to one inch thick. Or, you can simply provide a shelf flush with the bottom of the opening. The rubber feet are not used in such mounting. In a cabinet which provides for "face up" mounting, the AF-6 can simply be supported in the cutout by its front panel.

## CIRCUIT DESCRIPTION

The following brief explanation of the essential circuit features of the AF-6 may aid service personnel and the technically inclined hobbyist to understand the operation of this tuner. Those not interested in the technology may ignore this section.

### Front End

The FM front end provides a tuned RF input to a dual gate MOSFET RF amplifier with interstage double tuning to the dual gate MOSFET mixer which is driven by a transistor oscillator. The fourth FM section of the tuning capacitor tunes the oscillator. Both mixer and oscillator circuit constants have been carefully adjusted to provide uniform sensitivity over the entire FM band.

The FM AGC signal is taken from the high side of the IF output, through a transistor amplifier, a double diode detector, and applied to gate #2 of the RF input MOSFET.

The ferrite loopstick AM antenna, (or its external winding) input signal is tuned by the first of three AM tuning capacitor sections. The others tune the RF stage and the oscillator.

### AM IF Amplifier—Detector—AGC

The IF bandpass characteristic is determined by a twelve section LC filter after the first IF amplifier. With additional amplification, the audio signal is detected by pre-biased diode D105, and fed to the low pass filter network which includes a 10 kHz notch to suppress off-channel interference. It then goes through the audio bandpass switch to the audio amplifier portion of the PC-26 circuit board.

The dual diode detector D101-D102 provides a signal strength indication and AGC signal. The collector of AGC amplifier Q105 is a negative-going AGC voltage, feeding both Q101 and the front end input.

The B+ voltage is delay-switched for FM or AM by Q108 and Q109. With AM on, an offset voltage is applied to the FM muting circuit to lock out the indicator light.

### FM IF Amplifier—Limiter—Detector

The first IC intermediate frequency amplifier is followed by a 4-pole ceramic bandpass filter, another IF amplifier, an additional 4-pole ceramic filter, and a high gain limiting amplifier. The IF gain is so high, with such effective limiting, that limiting occurs on input noise alone. These IF circuits were carefully designed for minimum phase shift across the pass band, for phase shift in FM is analogous to amplitude distortion in an audio amplifier. This design maintains low distortion of the audio signal all the way down into the noise, and permits useful reception of very weak signals.

A high gain IC amplifier drives a ratio detector which provides an emitter follower audio output. The audio goes through a phase compensation network and a low pass filter with a 67 kHz notch to reject SCA sub-carriers, and then through the muting FET.

### FM Multiplex

The IC multiplex circuit is a cross-coupled multiplier demodulator which provides additional 67 kHz rejection.

A low pass filter with dual notch rejection at 19 kHz and 38 kHz is followed by the deemphasis network, the volume control, and an audio amplifier with 28 dB of gain. The output impedance of the audio stage is 1000 ohms, permitting long connecting cables with low losses. The AUDIO and TAPE outputs are paralleled and their level is set by the volume control.

### Meter

The FM meter circuit amplification is specifically designed to reflect maximum differentiation of the weakest signals for optimum antenna orientation, while defining as well those signals which reach unusually high intensity, and thus may require attenuation. FM meter feeds are obtained after the first ceramic filter and after the limiting amplifier.

A separate AM meter amplifier Q107 is fed by the dual diode detector D101-D102 for more linear signal strength indication as an aid to AM tuning.

### FM Muting

The FM audio muting action is controlled by a combined logic circuit which is fed by the detector output. It senses the detector's DC shift, and switches off the audio (mutes) when the variation from center exceeds 80 kHz. It is also activated by a second signal which is the output of a 150 kHz high pass filter. Any (interstation) noise at this point is amplified, and its presence switches off the audio.

### Dynatune

This automatic FM tuning logic circuit may be thought of as a highly amplified closed loop tracking circuit with a narrow "window." The detector's DC output is amplified by a high gain operational amplifier. This output is fed back to the front end through a limiter in what may be considered a servo-loop. This signal controls the frequency of the oscillator, and tracks for zero DC at the detector output. With proper factory alignment, the zero DC detector output can be assured of being the preset minimum distortion point.

The output of the servo amplifier must be switched off, or it would lock on one signal all the time. The AFC "window" is controlled by the limiter independent of the muting action. When the DC level reaches a predetermined value at the detector output by the action of moving the dial, the muting logic circuit switches off the servo-loop before audible noise or distortion is observed. Only when the muting logic circuit perceives a lack of interstation noise will the audio (and the servo-loop) be switched on again.

### FM Indicator Lights

The "Tuned" light is switched by the output of the muting logic circuit. The "Stereo" light is actuated by the same circuit, plus the presence of the 19 kHz multiplex carrier. It has a longer time constant, however, to avoid any audible noise accompanying its operation.

### Power Supply

The full wave bridge rectified supply includes zener diode (shunt) regulation on the negative side, and series transistor regulation on the positive side.

## GETTING THE MOST FROM YOUR FM TUNER

The simple 300 ohm twinlead dipole FM antenna supplied with your AF-6 will be convenient to use. Because of the extreme sensitivity and excellent quieting characteristic of your Dynatuner, this antenna will be capable of meeting the requirements in many typical installations.

This folded dipole type of antenna has equal pickup from opposite directions, and has maximum response to a signal coming from right angles (broadside) to the top of the "T." Therefore best reception will be achieved when it faces toward (points 90° from) the direction of the station. While such an antenna can be placed under a rug, or simply dangled from the back of the tuner, better reception will usually be obtained when it is mounted higher up. It can be tacked to the back of a cabinet, taped along wooden bookshelves, pinned along the back of a sofa or even against a wall. It should not be attached to any metal surfaces (these will tend to "absorb" the signal) and it should not be folded over, for this will adversely affect reception.

If you find that reception is not satisfactory with the antenna supplied and an outside, roof-mounted antenna is not practical, you may be able to improve directionality by using an ordinary set of TV "rabbit ears" of the simplest form. These have the added virtue of mobility in difficult areas. They can be turned to effect maximum pickup from different directions or moved to avoid particular room interference effects. They usually work best when they are extended horizontally. Connect them to the outer 300 ohm antenna screw terminals.

With any indoor antenna, the building structure may reduce its performance. This is particularly true of steel reinforced concrete structures, which often shield antennae all too well. Similarly, furniture placement and the movement of people through the room can affect the reception of some signals. Often the simplest solution is to fasten the antenna to the outside of a window ledge, or to a board mounted outside the window. Be careful that the lead-in is not squeezed by the window. If necessary, the lead-in (the portion which has the connecting lugs) may be extended with similar type wire.

### Roof-Mounted Antennas

By far the most satisfactory results from any quality stereo FM tuner will be obtained with a roof-mounted, directional antenna. The general rule of thumb is that if a television set requires an external antenna, so too will an FM tuner. The same effects you see as "ghosts" on television are apparent as multipath dispersion in stereo FM. Such effects are most common in cities where tall buildings provide many signal reflections, but trees and hills can also cause similar effects.

When selecting an antenna, competent advice from a local dealer who has experience with various systems, and knows the needs of your location, can be of great help. Here are some general tips which may assist you.

There are three criteria by which an antenna should be judged: gain, directionality and front-to-back ratio. Gain is the amount of signal amplification provided. Directionality refers to the sharpness of its acceptance pattern in selecting one compass direction, and minimizing signals from widely divergent compass points. The front-to-back

ratio is a separate element of directionality, in that it specifies the ability to reject a signal coming from the rear. Some highly directional antennae are capable of picking up signals from the rear almost as well as from the front, and thus have a low front-to-back ratio.

Yagi or log periodic antennas should be used, though they are more costly than the omni-directional (non-directional) designs. Non-directional antennas are more subject to multipath effects, and offer no more gain than the folded dipole, though the roof location may afford some improvement in reception of some signals.

In the city there is usually plenty of signal strength, but the reflections from surrounding buildings require good directionality and an excellent (high) front-to-back ratio for good stereo reception. Unfortunately, to obtain these, it is usually necessary to buy a high gain antenna. As a result you may find that you have such high signal intensities that some stations may come in at several points on the dial. These are known as images, or spurious responses, from which no tuner is immune. To overcome these, you can install an attenuator, or resistive network at the input terminals to "pad down" the signal. A type which can be switched out would enable you to pick up weak stations when desired. Write Dynaco for details.

For suburban locations, like those in "fringe areas," you need only consider gain if you are interested in receiving the maximum number of stations clearly. A strong local transmitter can impose special directional considerations, though.

If all of your stations are from one general direction, the antenna may be rigidly mounted facing that way. Or, if they are from two opposite directions, an antenna with reasonable gain and directivity, and a low front-to-back ratio may work well. However, if they are from many directions of the compass, you should use an antenna rotator.

If you are in a difficult reception area, you may find that changes in mast location, as well as its height, may effect improvements. In some cases, tilting the antenna off the horizontal is beneficial. Note that by far the most-used location is the least satisfactory: the chimney. Antennas are adversely affected by contamination, and heat affects the lead-in. A chimney supplies both in abundance.

The best antennas for FM use are cut specifically for the FM band, which lies between TV channels 6 and 7. Most television antennas also provide reasonable FM sensitivity, and these, with a single lead-in can be used with a two-set coupler, or splitter, to provide slightly reduced signals to both FM and TV. Some television antenna systems actually reject the FM band. This may be the case in some apartment house distribution systems, though the more recent ones include FM as a rule.

If two antennas are mounted on the same mast, locate them at least 3 feet apart to minimize interference between them. Do not connect the terminals of one antenna to the terminals of a different antenna so as to use a single downlead. Always use separate lead-ins. This is quite a different matter from "stacking" or properly combining two similar antennas in close proximity to obtain a boosted more directional signal in extreme fringe locations.



## Lead-In Wire

There are three basic criteria in selecting the appropriate lead-in: impedance matching (to avoid unnecessary signal loss), signal loss characteristic (expressed in db/100 feet), and shielding, or intrinsic resistance to interference.

There are two impedances of FM systems: 72 (or 75) ohms, and 300 ohms. The AF-6 provides for direct connection of either. The majority of antennas are designed for 300 ohm systems, but matching transformers, or baluns, may be used to convert from one antenna impedance to the other lead-in impedance with minimum signal loss. There are several types of 300 ohm lead-in, but only one 72 ohm in common use—coaxial shielded RG-59U. For extremely long runs, RG-11U is a lower loss equivalent.

RG-59U is used in many apartment house distribution systems and cable TV systems for it has relatively low signal loss and good life expectancy and very good shielding. It is fairly expensive and somewhat bulky, and the installation of connectors is a nuisance, but it is still preferred by many installers where interference, such as from motor vehicles, is a problem.

The most popular 300 ohm lead-in is the flat "ribbon" twinlead. It is the least expensive, has fairly low signal loss (at least when it is new), and low bulk, so it can be run (though with adverse effect on signal) under carpets and along walls with minimum unsightliness. Since it has no shielding, installers try to avoid horizontal runs as much as possible, stay away from metal surfaces like gutters and downspouts, and twist it about once each foot to reduce interference pickup. Twinlead is more subject than most to the effects of weather, and it should be replaced after about 3 years in most localities.

In fringe areas where maximum signal transmission is important, a special open wire 300 ohm twinlead uses plastic spacers to support the two conductors with a minimum of loss. It, too, has no shielding capability, and is affected by the elements. Weather resistance has been improved with some types of oval twinlead, both hollow and foam-filled, at the expense of considerable bulk and increased cost.

## ASSEMBLY INSTRUCTIONS

Assembly of the AF-6 is exceptionally simple when compared to other kits. The preassembled etched circuit boards have saved you much of the work, and the assembly that remains is arranged in an open, uncluttered layout that makes wiring quick and easy. The construction time will be only a few hours, but it is best to work slowly and carefully rather than worry about the time.

Construction will be greatly simplified if you have someone help you by reading the steps aloud, selecting the required parts, and preparing the necessary wire lengths as you proceed.

When you unpack your kit, check off the components against the parts list at the back of the manual. You can identify unfamiliar parts by matching them to the pictorial diagram or photograph.

Have the proper tools at hand before starting assembly. You will need a pencil-type soldering iron of 30- to 60-watt rating with a small tip, long nosed pliers, diagonal cutting

The most recent variation is shielded 300 ohm cable. It is the most expensive, with moderate signal loss, and is the bulkiest of all. It is well shielded and has good life expectancy, so it is preferred by many installers in urban areas.

The right choice of antenna and lead-in can take maximum advantage of the AF-6's superior performance. The antenna system is a substantially greater factor than any tuner design characteristic in achieving good reception of weak signals. The Dynatuner's front end has such low noise that it is doubtful if any form of booster or antenna amplifier can provide a signal with any listenable improvement over that directly from the antenna.

The critical listener may well spend as much for the antenna system as for the AF-6, but such a combination will accomplish far more than a rudimentary antenna attached to tuners several times the cost of the AF-6.

## OPERATION OUTSIDE THE UNITED STATES CONNECTIONS FOR 240 VOLT AC LINE

The power transformer supplied in the AF-6 may be connected for a 240 volt AC line as well as for the standard 120 volt AC line, which is how the transformer is wired unless this manual is stamped "240 volt." The transformer has dual primary windings. They are connected in parallel for 120 volts, and in series for 240 volts. The notes to steps 46 and 47 (p. 22) of the wiring instructions, and the diagram on the pictorial insert detail the 240 volt connections.

The 1/10 ampere (100 ma) slo-blo fuse supplied with 120 volt wiring should be replaced with a 1/16 ampere (62 ma) slo-blo fuse when the tuner is wired for 240 volt use.

The AF-6 is designed for use with either 50 Hz or 60 Hz current. Variations of line voltage up to 10% from nominal value will not affect performance.

The standard 75  $\mu$ sec FM de-emphasis time constant used in the United States is used in many other countries as well. If your location uses the alternative 50  $\mu$ sec de-emphasis (common in Europe), capacitors C-64 and C-65 on the PC-26 board should each be changed to .0056 mfd.

pliers, a medium-sized screwdriver, and 60/40 rosin core solder not larger than 1/16" diameter. You will also find a damp sponge or cloth helpful to wipe the tip of the iron clean periodically. An inexpensive wire stripping tool is helpful, but some people prefer a single-edged razor blade for removing the insulation.

A good solder connection does not require a large amount of solder around the joint. A well-made connection looks smooth and shiny because the solder flows into the joint when both parts are hot enough.

There are four steps to making a good solder connection:

1. Make a good mechanical connection.
2. Heat both parts with the tip of the iron at the junction.
3. Apply solder to the junction until it melts and flows.
4. Allow the connection to cool undisturbed.

## ALL SOLDERING MUST BE DONE WITH A GOOD GRADE OF ROSIN CORE SOLDER.

Under no circumstances should acid core solder be used. Unmarked solder, cheap solder or any of doubtful origin should be discarded, and *separate solder fluxes should never be used*. The warranty is voided on any equipment in which acid core solder or acid type fluxes have been used. Silver solder is not suitable. The recommended solder is 60/40 (60% tin, 40% lead) **ROSIN CORE**. Do not confuse this with 40/60, which is harder to use.

If you have a soldering gun, it should be used with care, especially when working on the circuit boards. A soldering gun can provide more heat than is necessary, with some risk that an unskilled user might damage the board, and because it requires some time to heat each time the trigger is squeezed, many users tend to make poor solder connections simply because they do not wait long enough for it to reach its operating temperature each time.

You should realize that many of the more delicate components are less likely to be damaged in the soldering process if you use a hot iron for a short time, rather than a cooler iron for a longer period. You will also make a better connection with the hot iron. If you keep the iron clean by wiping the tip frequently, and occasionally add a small amount of solder to the tip, it will aid the transfer of heat to the connection. Do not allow too much solder to build up on the tip though, or it may fall onto adjacent circuitry.

One of the best ways to make a good mechanical connection is to bend a small hook in the end of the wire, and then to crimp the hook onto the terminal lug. The amount of bare wire exposed need not be exactly  $\frac{1}{4}$ -inch, but if it is too long, the excess might touch another terminal lug or the chassis. Do not wrap the wire around the lug more than one time, as this makes the connection difficult to remove if an error is made.

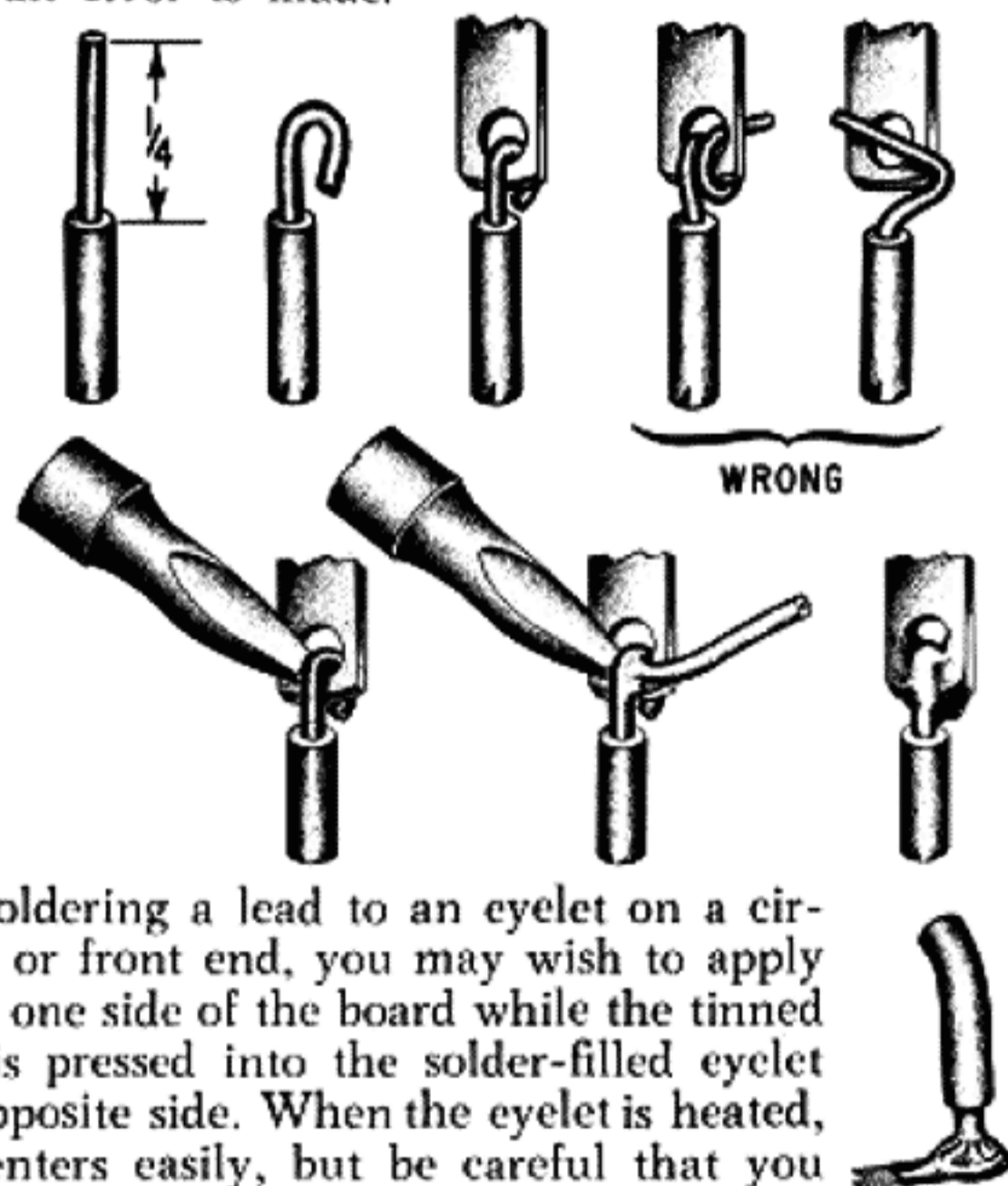

When soldering a lead to an eyelet on a circuit board or front end, you may wish to apply the iron to one side of the board while the tinned wire end is pressed into the solder-filled eyelet from the opposite side. When the eyelet is heated, the wire enters easily, but be careful that you *do not push the wire all the way into the eyelet up to the insulation*. If you do, you will not be able to see if you have made a secure connection, or if more solder is needed to provide a smooth flow from the wire, to the eyelet, and onto the circuitry on the board.

## WIRING THE KIT

The position of all wire leads should follow the diagram and photograph closely, bearing in mind that the pictorial diagram has necessarily been distorted somewhat to show all connections clearly. See that uninsulated wires do not touch each other unless, of course, they are connected to the same point. It is especially important that uninsulated wires or component leads or terminals do not touch the chassis accidentally.

Whenever one wire is to be soldered to a connection such as a lug terminal or eyelet, the instructions will indicate this by the symbol (S). If more than one wire is to be soldered to the same point, the instructions will cite the number of wires that should be connected to that point when it is to be soldered. If no soldering instruction is specifically given, do not solder; other connections will be made to that point before soldering is called for.

When the instructions refer to "tinning" a wire, apply the iron to the bared wire end, and after a moment, touch the solder to the wire so that the solder lightly coats the wire. This makes it easier to get a good connection when the wire is inserted into an eyelet, for example.

Check your work after each step, and make sure the entire step has been completed. When you are satisfied that it has been correctly done, check the space provided and go on to the next step. Be sure you read carefully the explanatory paragraphs in the assembly instructions.

Many of the wiring steps will call for "preparing" a wire of a certain length and color. This involves cutting the necessary length of wire and stripping  $\frac{1}{4}$  inch of insulation from each end. This is most easily done with wirestrippers, but diagonal cutters can be used if you are careful not to nick the wire and weaken it. With stranded wire such as transformer leads and line cords, be particularly careful not to cut the strands when stripping the ends.

The three etched circuit boards and the "front end" have been completely in-circuit tested at the factory. They have been precisely aligned as a matched set. When handling them be particularly careful that you do not disturb any of the adjustments on the variable resistors and the variable capacitor which are mounted on them. Since these assemblies include all of the active components, this assures their operation to specification as a complete tuner. Only the interconnection of these parts is left to you.

Transistor equipment, unlike much tube equipment, will not tolerate wiring errors, sloppy or incomplete soldering. **TAKE THE TIME TO BE NEAT AND ACCURATE**, and your tuner will operate properly at first, and for many years to come.

Two sizes of screws and nuts are supplied with the kit: the small #4 size, and the large #6 size. For your convenience, no #4 lockwashers are supplied. Use #6 lockwashers when #4 hardware is called for. A "set" of hardware includes one each screw, nut and lockwasher.

All mounting screws are installed from the *outside* of the chassis, and a lockwasher is used under each nut, except when otherwise specified.

When checking the hardware, take special note of the following, separating them so they will not be confused with more common hardware until called for in the instructions: Four #6 self-tapping screws with a scored tip and blue color; two #4 screws which are  $\frac{5}{16}$ " long; and two #4 locknuts with plastic inserts.

## Mechanical Assembly

- 1 ( ) Select the back panel and the small hinged plastic feedthrough. (A larger similarly shaped black piece is the strain relief for the line cord, to be mounted later.) Insert the smaller section of the feedthrough from the *outside* (printed side) into the larger round hole near the top right corner of the back panel. Then press the second half through the center hole until it snaps solidly against the panel.

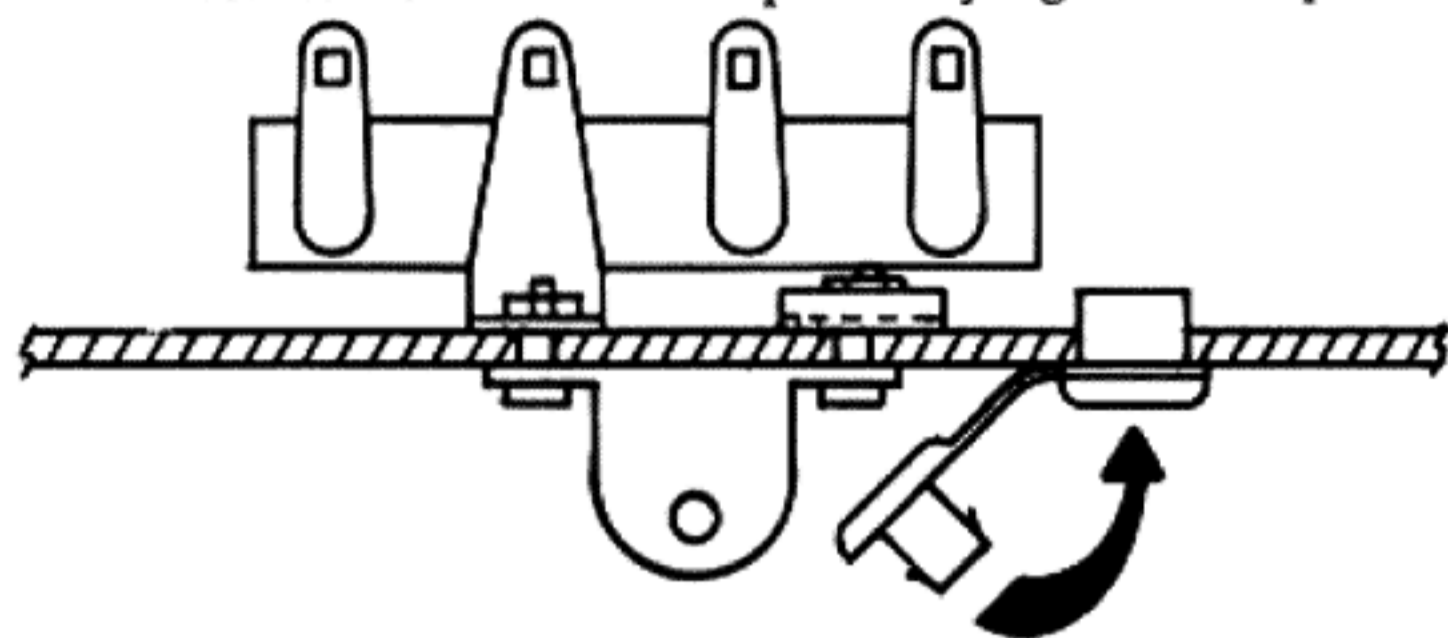

- 2 ( ) Select the two 5/16" long #4 screws (slightly longer than most), two lockwashers and #4 nuts, the smaller U-shaped metal bracket, the plastic cable clamp, and the 4-lug terminal strip. Install the bracket outside, horizontally, adjacent to the feedthrough, with the cable clamp inside (flat side against the panel), fastened *loosely* on the nearest screw. The terminal strip is secured inside to the second screw, as in the diagram.

- 3 ( ) Select the 4-screw terminal strip, a ground lug, a lockwasher and two each #4 screws and nuts. Install this strip from the *outside* of the panel, with the lugs toward the inside *bottom* edge of the cut-out marked "antenna." The ground lug is installed on the screw nearest the center of the panel, pointing downward. Be sure the ground lug is tight.

- 4 ( ) Select the AC outlet, a ground lug, a lockwasher and two each #4 screws and nuts. Install the outlet from the *inside* at the upper right corner of the panel with the ground lug pointing downward on the screw nearest the terminal strip.

- 5 ( ) Select the two pairs of audio output sockets and 8 sets of #4 hardware. Install the socket strips from the *inside* at the left of the panel.

- 6 ( ) Select the fuse holder. Remove the nut and lockwasher, leaving the rubber washer in place. Install the holder with the lockwasher and nut on the *inside* of the panel, noting that a flat on one side mates with a corresponding portion of the hole marked "fuse" on the panel.

- 7 ( ) Select the line cord and the plastic strain relief. Separate the two conductors for a distance of 11 1/2" from the end. Cut off 9" from *one* conductor, and strip 1/4" of insulation from both wires *if necessary*. Twist together the separate strands of each conductor. Bend the cord sharply back on itself at the point where the two conductors are joined, and squeeze the bend with pliers to form a sharp "V." Install the strain relief at the "V" as shown below with the small end of the strain relief nearest the bared wire ends. Use pliers to squeeze the two halves of the strain relief together around the wire, to partially shape the wire before insertion.

Then grasp only the larger diameter part of the relief with the tips of the pliers as shown, squeeze it fully closed, and insert the bared ends of the relief from *outside* the back panel through the remaining hole in the panel. The relief will snap into its locked position when fully inserted.

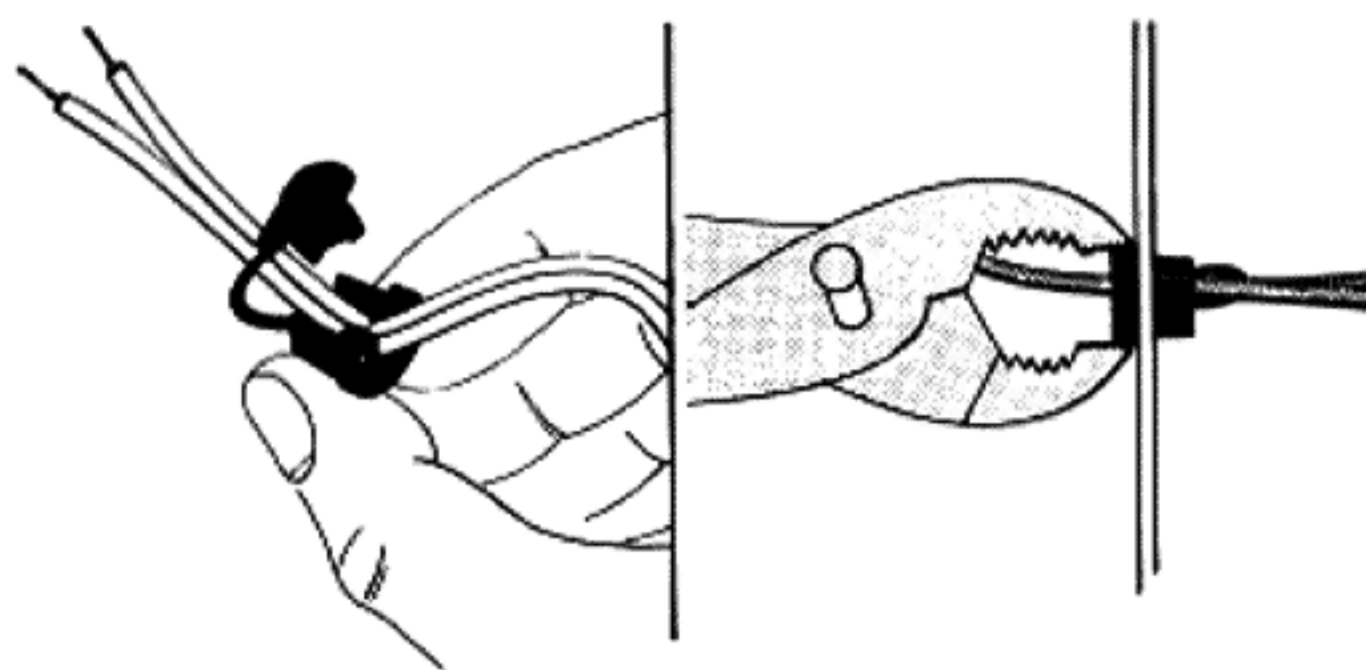

- 8 ( ) Select the black plastic antenna clip and one set of #4 hardware. Insert the screw from the *inside* of the clip, and mount it on the *outside* of the back panel next to the upper pair of audio output sockets.

Set the back panel aside and select the large chassis bottom plate and place it upside down, so it is resting on the side flanges. The front edge of the chassis is the one which has holes only in the corners.

- 9 ( ) Select the 4 rubber feet and four sets of #6 hardware. A foot is mounted in each corner hole of the chassis by placing a foot over the hole with the recess facing you, and forcing the screw fully into the recess in the foot. Secure each with a lockwasher and nut.

- 10 ( ) Select the power transformer, the 3-lug terminal strip, and two sets of #6 hardware. Install the transformer inside the right rear corner of the chassis (side flanges upright) with the black and violet pairs of wires next to the right hand edge of the chassis. Install the terminal strip on the rear corner mounting screw before the lockwasher and nut, as shown in the pictorial diagram.

- 11 ( ) Select a ground lug and a #4 screw and nut. Install the lug, pointing left as in the diagram, in the single isolated hole near the center of the chassis, 5" from the left edge.

- 12 ( ) Set the chassis aside, and select the front chassis panel, the volume control, and a 3/8" lockwasher and nut. Slip the lockwasher onto the control shaft and then install it at location VC. Position it so that the lugs are facing to the left as in the diagram, and tighten the nut. The volume control has been supplied with a fibre insulating washer on the *back*, held in place by the two lugs. Be sure this is secure.

- 13 ( ) Select the DPTT rocker switch with 8 lugs, one 3/4" #4 screw, one of the tubular spacers, and a lockwasher. Install the screw in the left (*outside*) mounting hole of location DS. Slip on the lockwasher, followed by the spacer, and thread it into the switch, but do not tighten it yet. Nuts are not required on this switch.

- 14 ( ) Select the QPDT switch (4 rows of 3 lugs each), a 3/4" #4 screw and one of the tubular spacers.

- Place the switch in location AS and insert the screw into the mounting hole between the switches, through switch AS, then through the spacer, threading it into the flange of switch DS. Tighten both screws. No lockwasher is used on switch AS.
- 15 ( ) Select the TPTT switch (3 rows of 4 lugs each), another  $\frac{3}{4}$ " #4 screw, a tubular spacer, a ground lug, and a #4 nut. Insert the screw through the panel and the right flange of switch AS, then through the spacer. Place the third switch in location MS over the screw with the closely spaced rows of lugs toward the bottom of the panel. Install the ground lug pointing upwards, and install the nut *loosely*.
  - 16 ( ) Select another  $\frac{3}{4}$ " #4 screw, the remaining spacer, a lockwasher and nut. Install the screw in the last switch mounting hole, first through the washer, then the spacer, the switch, and the nut. Tighten both nuts.
  - 17 ( ) Set the front panel aside for a moment and select the long black-front sub-panel and the two blue lamp covers. Handle the black-finished pieces with care to avoid fingerprints or scratches on the exposed portions. Be careful of the teflon tape along the top of the angled flange. Insert the two lamp covers through the round holes from the black side of the panel. Each is a snug fit. These should not be forced all the way through to where the cap touches the panel. Leave about  $\frac{1}{8}$ " clearance so that when the meter cover is installed next, these will be held tightly against the cover.
  - 18 ( ) Select the black meter cover, the meter, and two #6 sheet metal screws. *Remove the fine wire wrapped around the meter lugs.* Bend the lugs to the rear for clearance, and insert the meter from the black side of the sub-panel with its scale toward the outer edge. See that the meter scale is seated in the cut-out, and install the meter cover so that it encloses the meter and lamp covers. Fasten it in place with the two screws through the holes in the rear *nearest* the blue lamp covers, tightening these securely.
  - 19 ( ) Select the T-shaped lamp bracket and two #6 sheet metal screws. Install the bracket so that it projects outwards, in similar fashion to the bracket at the other end of the sub-panel, and secure it *carefully* (check the alignment of the meter scale in the cut-out) with the two screws.
  - 20 ( ) Select the two clip-type lamp holders, two ground lugs, and two each #4 screws and nuts. Install a lamp holder at each end of the sub-panel on the *front* (black side) of each lamp bracket with the connecting lugs pointing towards the center of the panel. Insert the screw through the holder from the clip side, through the bracket, the ground lug, and secure it with a nut. The ground lug should point towards the top (angled flange) of the panel.
  - 21 ( ) Select a #6 screw and lockwasher, and one of the brass pulley supports. Place the lockwasher over the screw first. Insert the screw from the bottom of the bent bracket tab adjacent to the meter and attach the support to the bracket.
  - 22 ( ) Select the two tubular dial lamps with white reflectors, and install them in the holder clips. The amount of light on the dial can be adjusted by rotating these lamps. The suggested position of the lamp nearest the meter has the white reflector positioned away from the meter. The other lamp faces the reflector in the same direction, to reduce the brilliance from that source.
  - 23 ( ) With three sets of #4 hardware fasten the sub-panel assembly to the front panel assembly. Insert the screws from the outside of the panel.
  - 24 ( ) Select a #6 screw and lockwasher and another pulley support. Insert the screw from the front of the panel in the corner hole above switch DS. Add the lockwasher and attach the support.
  - 25 ( ) Select the tuning shaft assembly, a  $\frac{3}{8}$ " lockwasher and  $\frac{3}{8}$ " nut. Slip the lockwasher on the threaded portion of the shaft, install the assembly from the inside in the hole below the pulley support and secure with the nut. The loop of the "hairpin" spring should point to the adjacent upper corner of the panel.
  - 26 ( ) Set the front panel assembly aside and select the "front end" (the complex metal box with a circuit board and many components mounted on its top). Do not disturb any component adjustments. Because of the highly critical tuned circuitry of the front end, damage to it may likely require its complete replacement, so *care is essential*. Select the two odd-shaped metal front end mounting brackets, the four special blued finish  $\frac{3}{16}$ " thread-cutting screws, three lockwashers and a ground lug. Slip a lockwasher on each screw and install the larger bracket on the shaft side of the front end with two screws so that the narrower surface projects outwards along the bottom, and the longer surface extends up near the circuit board. Install the other bracket on the opposite end with the screws through the solid portion, leaving two projecting feet. The ground lug is installed in place of a lockwasher on the screw farthest from the circuit board. The lug should point upwards.
  - 27 ( ) Select the remaining brass pulley support, a #6 round head screw and lockwasher. Place the lockwasher on the screw, and insert the screw from the circuit board side of the upright bracket, attaching the pulley support adjacent to and parallel with the front end shaft. *Be careful of the circuit board.*
  - 28 ( ) Select the 2" diameter metal tuning pulley and install a set screw with the L-shaped Allen wrench. Turn the front end shaft fully counter-clockwise, and install the pulley on the shaft, hub outwards, with the set screw pointing to the notch in the base of the bracket. Tighten the set screw with the shaft protruding  $\frac{1}{8}$ " beyond the pulley hub.
  - 29 ( ) Set the front end aside where it is protected, as it will be installed much later. Select the back panel assembly, the U-shaped metal bracket, the long tubular AM antenna, the two remaining  $\frac{3}{4}$ " #4 screws, and the two special locking nuts which

have plastic inserts. Note the two "ears" near the base of the U-bracket. Lay the bracket on the ears, open end of the U away from you, and place the antenna flat between the U, with its leads extending towards you, under the center of the U. The leads should enter the tube close to the work surface. Align the pair of bracket holes farthest from you with the hole through the antenna and insert a screw through the left side of the bracket, through the antenna, and secure it with a locknut on the right side. These nuts are harder to install but will not come loose. The nut should be fairly snug, to permit some swivel action without looseness. Now thread the fine leads through the plastic feedthrough from the outside of the back panel, followed by  $\frac{3}{4}$ " of their sheath. Insert the antenna bracket into the U-bracket already mounted on the panel. The "ears" should be nearest the feedthrough. Install the remaining screw from the top, through both brackets, and secure it with a snug locknut. Loosen the mounting bolt holding the cable clamp inside the panel. Pass the sheathed leads through the clamp, so that the clamp's flat surface will be against the panel. Be sure that sufficient slack remains outside so that the antenna may be rotated to any position without strain. Fold the antenna flat against the panel, and snap it into the antenna clip. Reinstall the clamp and lock-washer and tighten the nut.

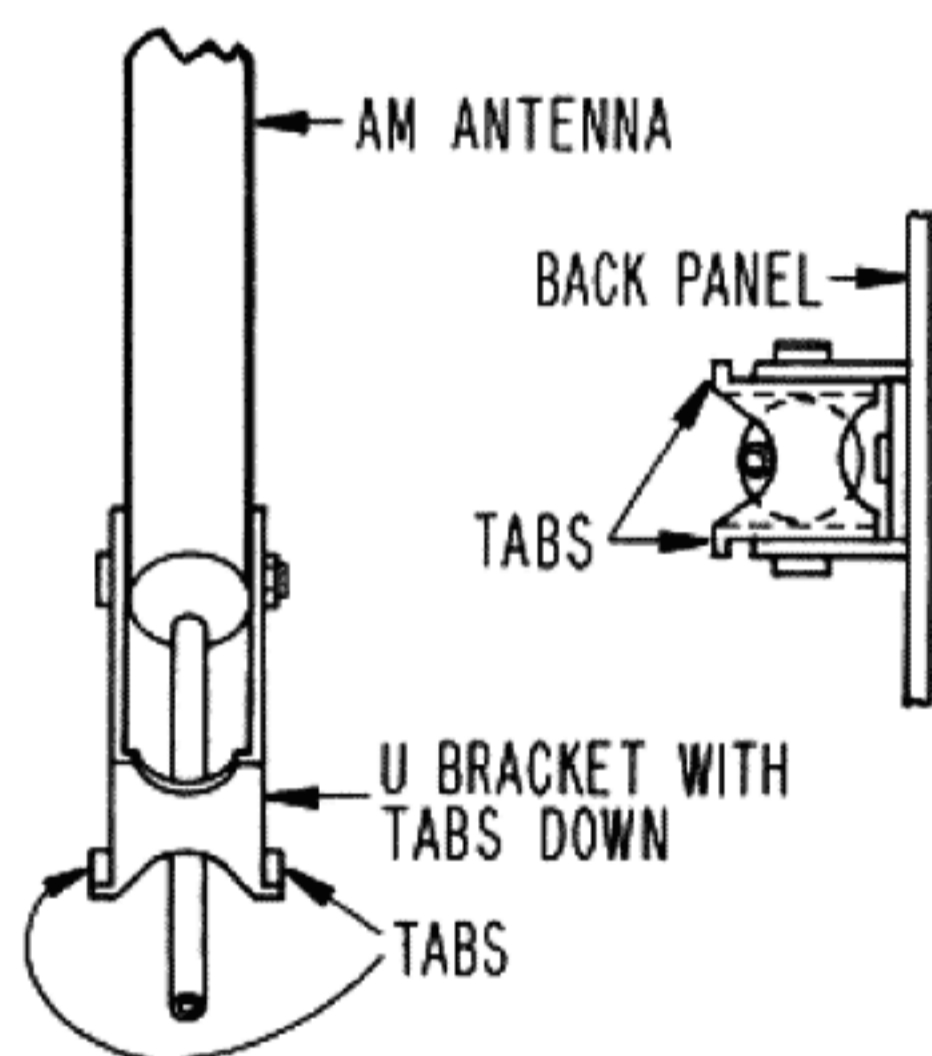

This completes the mechanical sub-assembly portion of your work. Before commencing wiring, you may wish to install the four remaining setscrews in the knobs and in the flywheel (where two are used) to avoid their loss.

### Sub-Assembly Wiring

When "tinning" is called for, be sure the tip of the iron is first wet with solder to make heat transfer easy. Then apply the iron to the bared wire end, and after a moment touch the solder to the junction so that the solder lightly coats the wire.

- 1 ( ) Prepare a  $1\frac{1}{2}$ " black wire. On the back panel assembly, connect one end to the *short* lug adjacent to audio output socket #1. (S). Connect the other end to the *short* lug adjacent to audio output socket #2. (S).

- 2 ( ) Prepare another  $1\frac{1}{2}$ " black wire. Connect one end to the *short* lug adjacent to audio output socket #3. (S). Connect the other end to the *short* lug adjacent to audio output socket #4. (S).
- 3 ( ) Twist together the strands at the end of each conductor of the line cord, and "tin" them with solder to prevent fraying. Connect the shorter conductor to the tip lug #1 of the fuse holder.
- 4 ( ) Prepare a  $2\frac{1}{2}$ " black wire. Connect one end to the tip lug #1 of the fuse holder. (S-2). Connect the other end to lug #1 of the AC outlet.

NOTE: IF THIS UNIT IS OBTAINED IN CANADA, DO NOT SOLDER. AN INTERNAL FUSE WILL LATER ALSO BE CONNECTED TO THE TIP LUG.

- 5 ( ) Select the 3.3 megohm resistor (orange-orange-green), and trim each lead to  $\frac{1}{2}$ ". Connect one end to the ground lug on the AC outlet. Connect the other end to AC outlet lug #1.
- 6 ( ) Select the larger .01 disc capacitor (1KV), and trim each lead to  $\frac{1}{2}$ ". Connect one end to the same ground lug on the AC outlet. (S-2). Connect the other end to the same AC outlet lug #1. (S-3).
- 7 ( ) There are six wires emerging from the sheath of the AM tubular antenna. Three are already soldered together (one each green, white and red). Twist these together, and thread them through the hole at the base of lug #2 of the 4-lug terminal strip. These wires are connected to the base of the lug to avoid interference with other connections made to the lugs in subsequent steps. Leave a little slack to avoid stress on these delicate wires, and solder them to the lug. (S-3). When the soldering iron touches the wires, the insulation will melt away to enable an easy connection. Cut off the excess wires under the terminal strip. In like manner, connect the single white antenna wire to the base of lug #4 of the terminal strip. (S). Connect the single green wire to the base of lug #3. (S). Connect the single red wire to the base of lug #1. (S). Cut off the excess.
- 8 ( ) Select the 470 ohm resistor (yellow-violet-brown). Connect one end to lug #1 of the 4-lug terminal strip. Connect the other end to lug #1 of the 4-screw terminal strip. (S).
- 9 ( ) Select the 180 pf disc capacitor and trim each lead to  $\frac{1}{2}$ ". Connect one end to lug #1 of the 4-lug terminal strip. (S-2). Connect the other end to lug #2 of the strip.
- 10 ( ) Prepare a  $1\frac{1}{2}$ " black wire. Connect one end to lug #2 of the 4-screw terminal strip. Connect the other end to the ground lug next to lug #1. (S).
- 11 ( ) Select the FM antenna matching coil, which has two single wires and a twisted pair. The two single wires are interchangeable but are insulated from each other. If excessive heat or stress breaks down the enamel insulation between them, FM reception will be impaired. Trim each lead to about  $\frac{3}{4}$ ". Connect the twisted pair of leads to lug #2 of the 4-screw terminal strip. Connect one of the single wires to lug #3. Connect the other single wire to lug #4. (S).

- 12 ( ) Select the length of coaxial shielded cable. You will make up four lengths with stripped and *tinned* ends as illustrated. Start with the longest one and complete one at a time so that if you slip and cut through the shield, center insulation or center conductor, you can use that piece for a shorter length. One end of each of the two *shortest* pieces will be inserted into eyelets on a circuit board. To make this easier, cut off half of the shield strands on one end of each before twisting them together and tinning them. You must use care in removing the insulation so that you do not cut the fine strands underneath. With the outer insulation removed, a needle or pin is often the easiest implement for separating the woven shield strands, so that they may be drawn to one side and twisted together. Do not twist them so tightly that they can cut through the center insulation when it gets soft from the heat in the tinning process.

#### WIRE LENGTHS:

- 7"
- 6½"
- 5½" (one end with smaller shield)
- 4½" (one end with smaller shield)

**TAKE YOUR TIME!** This is the most tedious part of the kit. Care now can save you a lot of trouble-shooting later.

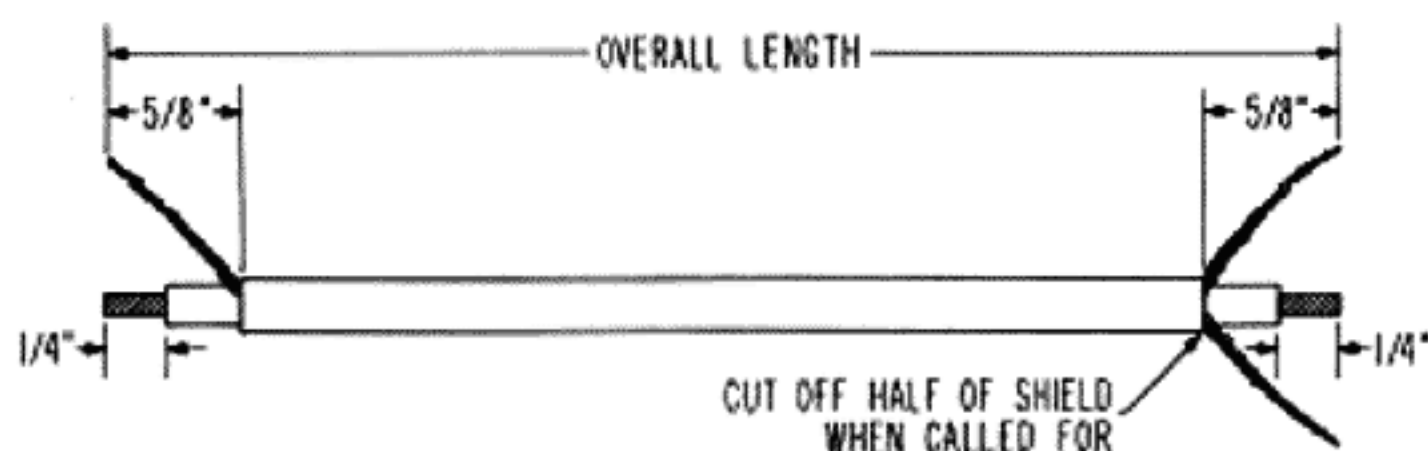

- 13 ( ) Select the 6½" length of the prepared coaxial cable and connect the shield of one end to lug #2 of the 4-screw terminal strip. (S-3). In soldering every shield connection be careful that you do not apply excessive heat which could melt through the insulation for the center conductor. Connect the center conductor to lug #3 of the strip. (S-2).
- 14 ( ) Select the 150,000 ohm resistor (brown-green-yellow). Trim each lead to ¾" and connect one end to lug #4 of the 4-lug terminal strip. Connect the other end to lug #2 of the strip.
- 15 ( ) Select the 7" length of prepared coaxial cable and connect the shield of one end to lug #2 of the 4-lug terminal strip. (S-3). Avoid excessive heat. Connect the center conductor to lug #3 of the strip. (S).
- 16 ( ) Select the piece of heavy gauge wire and cut a 5½" length. Strip ¼" of insulation from one end, and ¾" from the other end. Connect the shorter bared end to lug #4 of the 4-lug terminal strip. (S-2).

Set the back panel aside and place the front panel sub-assembly before you. Be careful you do not damage the teflon tape surface on the angled flange at the top of the panel. Roughness here will prevent the dial pointer from moving smoothly.

- 17 ( ) Strip bare two ¾" pieces of wire. Connect one between the left lamp holder lug #1 and the adjacent ground lug. Connect the other between right lamp holder lug #3 and the adjacent ground lug. *Solder all four lugs.*
- 18 ( ) Prepare an 11½" green wire. Connect one end to the left lamp holder lower lug #2. (S). Connect the other end to the right lamp holder lower lug #4. Tuck this wire under the sub-panel and behind the switches.
- 19 ( ) Select the 1 megohm resistor (brown-black-green), and trim each lead to ½". Connect one end to the ground lug between switches AS and MS. Connect the other end to MS lug #1.
- 20 ( ) Select the .01 mfd tubular 5% capacitor and trim each lead to ½". Connect one end to the same ground lug. (S-2). Connect the other end to the same MS lug #1. (S-2).
- 21 ( ) Prepare a 7½" black wire and a 7½" red wire. Twist them together throughout their length except for one inch at one end. Connect the black wire at this longer end to AS lug #5. (S). Connect the red wire to MS lug #5. Place the pair behind the ground lug, over switch MS. At the other end connect the black wire to meter lug #2. (S). Connect the red wire to meter lug #1. (S).
- 22 ( ) Prepare a 4½" red wire. Connect one end to MS lug #5. (S-2). Place this wire below switch AS and connect the other end to DS lug #6.
- 23 ( ) Prepare an 8" red wire. Connect one end to DS lug #6. (S-2).
- As long wires like the above are left with free ends, it is best to place them out of the way of your eyes underneath the panel assembly.
- 24 ( ) Prepare a 7½" green wire and a 7½" black wire. Twist them together throughout their length. Connect one end of the green wire to AS lug #8. (S). Connect the corresponding end of the black wire to AS lug #11. (S). Place this pair under switch MS and connect the other end of the black wire to VC lug #3. (S). Connect the corresponding end of the green wire to VC lug #6. (S).
- 25 ( ) Prepare a 1½" red wire. Connect one end to AS lug #12. Connect the other end to MS lug #10. (S).
- 26 ( ) Prepare a 1¼" green wire. Connect one end to AS lug #9. Connect the other end to MS lug #9.
- 27 ( ) Select the .0082 mfd capacitor, and trim each lead to ½". Connect one end to MS lug #9. (S-2). Connect the other end to MS lug #11. (S).
- 28 ( ) Prepare a 10" black wire and a 10" green wire. Twist them together throughout their length. Connect one end of the green wire to AS lug #9. (S-2). Connect the corresponding end of the black wire to AS lug #12. (S-2).

- 29 ( ) Prepare a 5 $\frac{3}{4}$ " green wire, but remove  $\frac{3}{4}$ " of insulation from one end. Thread the longer bared end through DS lug #3 from the *top*, and connect it to DS lug #8. Do not solder either of these lugs. Place this wire against the panel above the switches. Connect the other end to MS lug #7. (S).
- 30 ( ) Prepare a 9" black wire, but remove 1" of insulation from one end. Thread the longer bared end through DS lug #4 from the *bottom*, then across the top of the switch, and connect it to DS lug #2. *Solder both lugs.*
- 31 ( ) Prepare a 7" green wire, but remove 1" of insulation from one end. Thread the longer bared end through DS lug #7 from the *bottom*, then through the center of the switch and connect it to DS lug #5. *Solder both lugs.*
- 32 ( ) Select the 1 mfd tubular electrolytic capacitor. Cut each lead to  $\frac{1}{2}$ ". Connect the positive (+) lead to DS lug #3. (S-2). Position the capacitor straight out from the switch, and connect the other lead to DS lug #1.
- 33 ( ) Prepare an 8 $\frac{1}{4}$ " green wire and connect one end to DS lug #8. (S-2).
- 34 ( ) Prepare a 13" black wire and connect one end to DS lug #1. (S-2).
- 35 ( ) Prepare a 4 $\frac{1}{4}$ " black wire but remove  $\frac{1}{2}$ " of insulation from *both* ends. Thread one end through MS lug #2 from the *top* and connect it to MS lug #3. *Solder only lug #2* at this time. Place the wire against the panel above switch AS and thread the other end through AS lug #7 from the *top*, and connect it to AS lug #10. *Solder both lugs.*
- 36 ( ) Prepare a 9 $\frac{1}{2}$ " green wire, but remove 1" of insulation from one end. Thread the longer bared end through MS lug #8 from the *bottom* then through the center of the switch and connect it to MS lug #6. *Solder both lugs.*
- 37 ( ) Prepare a 7 $\frac{1}{2}$ " black wire. Connect one end to MS lug #3. (S-2).
- 38 ( ) Prepare a 7 $\frac{1}{2}$ " red wire. Connect one end to MS lug #4. (S).
- 39 ( ) Prepare a 7" red wire. Connect one end to AS lug #6. (S).
- 40 ( ) Prepare a 4 $\frac{1}{2}$ " black wire. Connect one end to AS lug #4. (S).
- 41 ( ) Prepare a 5 $\frac{1}{2}$ " green wire. Connect one end to AS lug #1. (S).
- 42 ( ) Prepare a 5 $\frac{1}{2}$ " red wire and a 5 $\frac{1}{2}$ " green wire. Twist them together throughout their length and connect one end of the green wire to AS lug #2. (S). Connect the corresponding end of the red wire to AS lug #3. (S).
- 43 ( ) Prepare an 11 $\frac{1}{2}$ " green wire and an 11 $\frac{1}{2}$ " red wire. Twist them together throughout their length, and connect one end of the red wire to VC lug #2. (S). Connect the corresponding end of the green wire to VC lug #5. (S).
- 44 ( ) Prepare a 10" black wire but remove  $\frac{3}{4}$ " of insulation from one end. Thread the longer bared end through VC lug #4 from the *back*, and connect it to VC lug #1. *Solder both lugs.*
- 45 ( ) Select the .02 mfd disc capacitor and the short piece of insulating sleeving. Trim each lead of the capacitor to  $\frac{1}{2}$ ". Cut two pieces of insulating sleeving  $\frac{1}{4}$ " long and slide one piece over each capacitor lead. Connect one end of the capacitor to VC lug #7. Connect the other end to VC lug #8.
- 46 ( ) Prepare a 12" red wire. Connect one end to VC lug #7. (S-2).

Set the front panel assembly aside. You will now prepare the three circuit boards for installation. In this section, whenever you prepare a wire, "tin" *both ends* by heating them and applying a small amount of solder before installation. It will make it easier to connect the wire to eyelets on the boards.

In most cases, it is easiest to heat the solder-filled eyelet until the solder melts, and then insert the wire, making sure the iron now touches both the eyelet and the bared wire so that a smooth flow of solder is apparent. Then remove the iron and hold the wire steady while the connection cools. Afterwards wiggle the wire to be sure the connection is secure and no movement is apparent from the other side of the board. There should be a smooth, shiny flow of solder from the wire to the eyelet and from the eyelet to the circuitry on the board, obscuring the eyelet. If in doubt, reheat the connection and add a bit more solder. Use reasonable care, for grossly excessive heat may cause the circuitry to separate from the board. If this happens you can make a repair by soldering a piece of bare wire along the affected area.

Be very careful not to "bridge" solder across adjacent eyelets where they are closely spaced. Also, do not allow any flecks of solder to fall onto the boards where they could create a bridge on that circuitry which would cause a malfunction and be very difficult to locate later, to say nothing of possible damage to components.

- 47 ( ) Select the PC-25 circuit board (which is slightly longer than the shortest board), two right-angle brackets, and four sets of #4 hardware. *Be careful you do not disturb* the settings of any of the adjustable components on these boards. The numbered eyelets are located along the bottom edge of the board. Lay the board components side down with the numbered eyelets toward you. While the eyelets will already be filled with some solder, it may be necessary to add a small amount of additional solder while heating each eyelet with your iron. Install the brackets on the components side (back) of the board with the base of the bracket extending away from the board. Insert the screws through the bracket first, then secure with a lock-washer and nut on the circuitry side of the board, which will be called the *front*, as this is how the boards will later be mounted on the chassis. Support the PC-25 board in an upright position with the eyelets on *top* so that the next 5 wires may be connected to the *back* (components) side.

**NOW TURN TO PAGE 20**

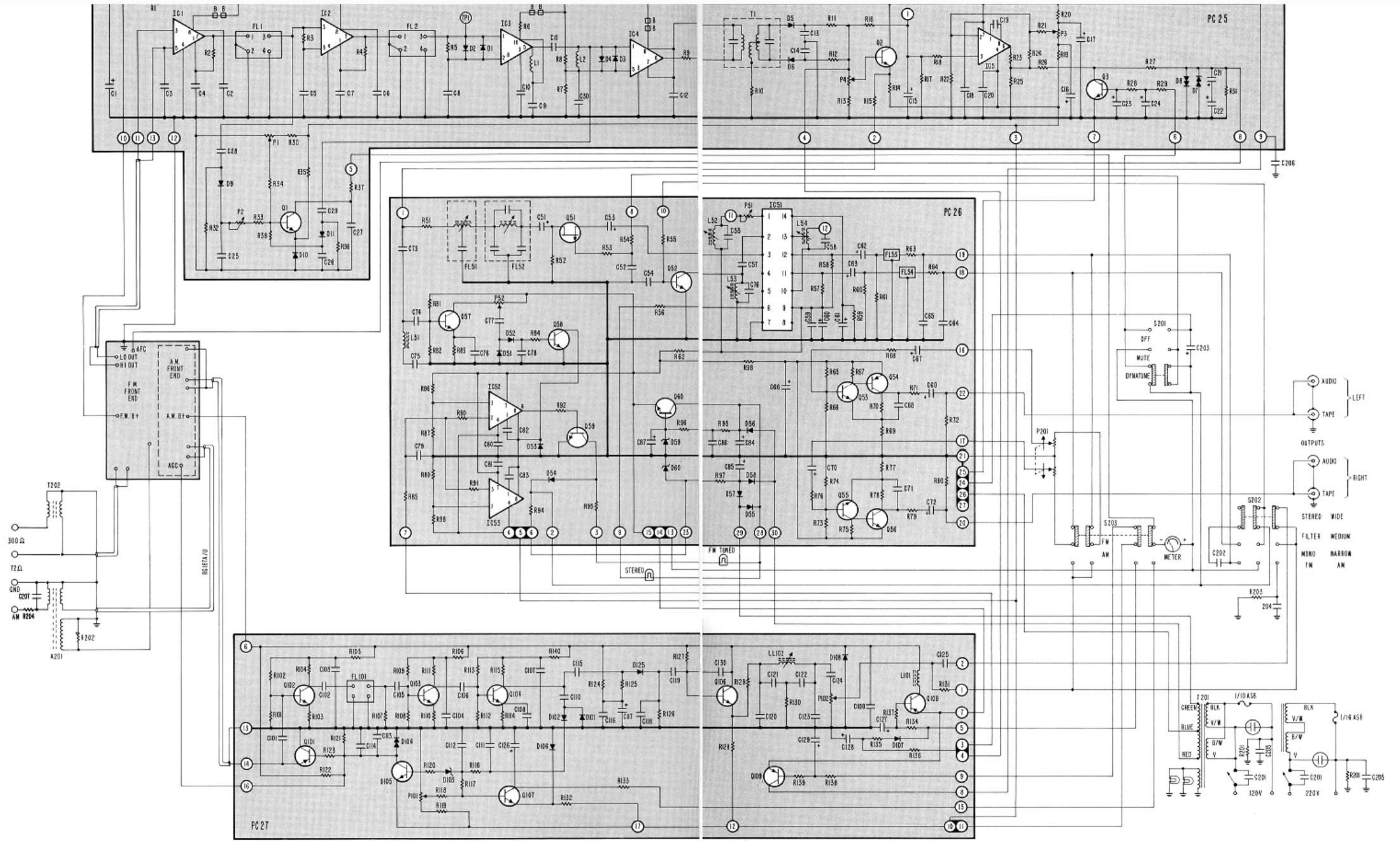

SCHMATIC DIAGRAM



## PARTS LIST FOR SCHEMATIC DIAGRAM

All resistors are ¼ watt, 10% tolerance unless otherwise indicated.

		PART #		PART #		PART #		
R1	47 ohms	117470	R66	180,000 ohms, 5%	119184	R121	12,000 ohms, 5%	119123
R2	330 ohms, 5%	119331	R67	12,000 ohms, 5%	119123	R122	47,000 ohms, 5%	119473
R3	330 ohms, 5%	119331	R68	1,000 ohms	117102	R123	8,200 ohms, 5%	119822
R4	330 ohms, 5%	119331	R69	82 ohms, 5%	119820	R124	390,000 ohms, 5%	119394
R5	330 ohms, 5%	119331	R70	2,200 ohms, 5%	119222	R125	22,000 ohms, 5%	119223
R6	240 ohms	117241	R71	1,000 ohms	117102	R126	220,000 ohms, 5%	119224
R7	2,200 ohms	117222	R72	220,000 ohms	117224	R127	220,000 ohms, 5%	119224
R8	1,200 ohms	117122	R73	2.2 megohm, 5%	119225	R128	1,000 ohms, 5%	119102
R9	240 ohms	117241	R74	180,000 ohms, 5%	119184	R129	270 ohms, 5%	119271
R10	68 ohms	117680	R75	12,000 ohms, 5%	119123	R130	3,000 ohms, 5%	119302
R11	5,600 ohms, 5%	119562	R76	1,000 ohms	117102	R131	47,000 ohms, 5%	119473
R12	5,600 ohms, 5%	119562	R77	82 ohms, 5%	119820	R132	4,700 ohms, 5%	119472
R13	39,000 ohms	117393	R78	2,200 ohms, 5%	119222	R133	47,000 ohms, 5%	119473
R14	10,000 ohms, 5%	119103	R79	1,000 ohms	117102	R134	33 000 ohms, 5%	119333
R15	100 ohms	117101	R80	220,000 ohms	117224	R135	100,000 ohms, 5%	119104
R16	47,000 ohms	117473	R81	8,200 ohms, 5%	119822	R136	100,000 ohms, 5%	119104
R17	100,000 ohms	117104	R82	1,200 ohms, 5%	119122	R137	22,000 ohms, 5%	119223
R18	2,200 ohms	117222	R83	1,000 ohms, 5%	119102	R138	22,000 ohms, 5%	119223
R19	15,000 ohms	117153	R84	1,000 ohms	117102	R139	22,000 ohms, 5%	119223
R20	15,000 ohms	117153	R85	100,000 ohms	117104	R140	270 ohms, 5%	119271
R21	470,000 ohms	117474	R86	22,000 ohms, 5%	119223	R201	3.3 megohm, ½ watt	112335
R22	10,000 ohms, 5%	119103	R87	390 ohms, 5%	119391	R202	150,000 ohms, 5%	119154
R23	8,200 ohms	117822	R88	22,000 ohms, 5%	119223	R203	1 megohm, 5%	119105
R24	1 megohm, 5%	119105	R89	390 ohms, 5%	119391	R204	470 ohm, 5%, ½ watt	113471
R25	2,200 ohms, 5%	119222	R90	2,200 ohms	117222	A201	AM ferrite loopstick ant.	414001
R26	47,000 ohms	117473	R91	2,200 ohms	117222	B	ferrite bead	417590
R27	47,000 ohms	117473	R92	10,000 ohms	117103	C1	200 mfd, 15v.	283207
R28	47,000 ohms	117473	R93	150 ohms	117151	C2		
R29	47,000 ohms	117473	R94	100,000 ohms	117104	to		
R30	27,000 ohms	117273	R95	560 ohms	117561	C12	.01 mfd, 100v., 20%	234103
R31	1 megohm, 5%	119105	R96	560 ohms	117561	C13	220 pf, 5%	245221
R32	10,000 ohms, 5%	119103	R97	150 ohms, 5%, ½ watt	113151	C14	220 pf, 5%	245221
R33	10,000 ohms, 5%	119103	R98	100 ohm	117101	C15	5 mfd, 15v.	283505
R34	100,000 ohms	117104	R101	24,000 ohms, 5%	119243	C16	1 mfd, 25v.	283105
R35	4,700 ohms, 5%	119472	R102	200,000 ohms, 5%	119204	C17	1 mfd, 25v.	283105
R36	10,000 ohms, 5%	119103	R103	270 ohms, 5%	119271	C18	.01 mfd, 100v., 20%	234103
R37	47,000 ohms	117473	R104	4,700 ohms, 5%	119472	C19	33 pf, NPO	247330
R38	22,000 ohms, 5%	119223	R105	270 ohms, 5%	119271	C20	.01 mfd, 100v., 20%	234103
R51	1,300 ohms, 5%	119132	R106	270 ohms, 5%	119271	C21	33 mfd, 10v.	283336
R52	220,000 ohms	117224	R107	2,200 ohms, 5%	119222	C22	33 mfd, 10v.	283336
R53	100,000 ohms	117104	R108	24,000 ohms, 5%	119243	C23	1 mfd, 25v.	283105
R54	100,000 ohms	117104	R109	100,000 ohms, 5%	119104	C24	5 mfd, 15v.	283505
R55	100,000 ohms	117104	R110	270 ohms, 5%	119271	C25	.01 mfd, 100v., 20%	234103
R56	150 ohms	117151	R111	1,500 ohms, 5%	119152	C26	.01 mfd, 100v., 20%	234103
R57	3,900 ohms, 5%	119392	R112	24,000 ohms, 5%	119243	C27	.01 mfd, 100v., 20%	234103
R58	3,900 ohms, 5%	119392	R113	100,000 ohms, 5%	119104	C28	12 pf, NPO	244120
R59	10,000 ohms, 5%	119103	R114	270 ohms, 5%	119271	C29	12 pf, NPO	244120
R60	220,000 ohms	117224	R115	1,500 ohms, 5%	119152	C30	.01 mfd, 100v., 20%	234103
R61	220,000 ohms	117224	R116	470,000 ohms, 5%	119474	C51	5 mfd, 15v.	283505
R62	100 ohms	117101	R117	390,000 ohms, 5%	119394	C52	.47 mfd, 100v., 10%	260474
R63	10,000 ohms, 5%	119103	R118	2.7 megohm, 5%	119275	C53	5 mfd, 15v.	283505
R64	10,000 ohms, 5%	119103	R119	100,000 ohms, 5%	119104	C54	.22 mfd, 100v., 10%	204224
R65	2.2 megohm, 5%	119225	R120	330,000 ohms, 5%	119334	C55	.01 mfd, 33v., 5%	263103

**PARTS LIST FOR SCHEMATIC DIAGRAM (Cont.)**

C56	.01 mfd, 33v., 5%	PART # 263103	C125	.0022 mfd, 100v., 10%	PART # 264222	IC4	IC LM3028	PART # 587028
C57	.1 mfd, 100v., 10%	204104	C126	5 mfd, 15v.	283505	IC5	IC LM301AH	587709
C58	.0022 mfd, 33v., 5%	263222	C127	50 mfd, 15v.	281506	IC51	IC MC1307P/ $\mu$ A769	587307
C59	.01 mfd, 100v., 20%	234103	C128	1 mfd, 25v.	283105	IC52	IC LM301AH	587709
C60	200 mfd, 15v.	283207	C129	20 mfd, 15v.	281206	IC53	IC LM301AH	587709
C61	5 mfd, 15v.	283505	C130	12 pf	244120	L1	27 $\mu$ h choke	413027
C62	5 mfd, 15v.	283505	C201	.02 mfd, 500v.	227203	L2	27 $\mu$ h choke	413027
C63	5 mfd, 15v.	283505	C202	.0082 mfd, 100v., 5%	264822	L51	.43 mh coil	422431
C64	.0082 mfd, 100v., 5%	264822	C203	1 mfd, 15v.	283105	L52	7 mh coil	422019
C65	.0082 mfd, 100v., 5%	264822	C204	.01 mfd, 250v., 5%	265103	L53	7 mh coil	422019
C66	200 mfd, 15v.	283207	C205	.01 mfd, 1000v., 20%	228103	L54	8 mh coil	422038
C67	1 mfd, 25v.	283105	C206	.01 mfd, 100v., 20%	234103	L101	.43 mh coil	422431
C68	.001 mfd, 100v., 10%	240102	C207	180 pf	224181	L102	10.7 mh coil	422107
C69	1 mfd, 25v.	283105	D1	germanium diode	543541	P1	10,000 ohms trimpot	140103
C70	1 mfd, 25v.	283105	D2	germanium diode	543541	P2	22,000 ohms trimpot	140223
C71	.001 mfd, 100v., 10%	240102	D3	silicon diode	543148	P3	4,700 ohms trimpot	140472
C72	1 mfd, 25v.	283105	D4	silicon diode	543148	P4	22,000 ohms trimpot	140223
C73	360 pf, 100v., 5%	254361	D5	germanium diode	543541	P51	470 ohms trimpot	140471
C74	560 pf, 100v., 5%	254561	D6	germanium diode	543541	P52	10,000 ohms trimpot	140103
C75	.01 mfd, 100v., 5%	205103	D7	silicon dual diode	546361	P101	100,000 ohms trimpot	140104
C76	.01 mfd, 100v., 20%	234103	D8	silicon dual diode	546361	P102	10,000 ohms trimpot	140103
C77	.22 mfd, 100v., 10%	204224	D9	germanium diode	543541	P201	volume control w/switch	180203
C78	1 mfd, 25v.	283105	D10	silicon diode	543148	Q1	transistor BC237A	577020
C79	.47 mfd, 100v., 10%	260474	D11	germanium diode	543541	Q2	transistor BC237A	577020
C80	.01 mfd, 100v., 20%	234103	D51	silicon diode	543148	Q3	transistor BC237A	577020
C81	.01 mfd, 100v., 20%	234103	D52	silicon diode	543148	Q51	FET 2N5462	597462
C82	.001 mfd, 100v., 10%	240102	D53	silicon diode	543148	Q52	transistor BC237A	577020
C83	.001 mfd, 100v., 10%	240102	D54	germanium diode	543541	Q53	transistor BC237A	577020
C84	500 mfd, 25v.	280507	D55	silicon diode	544012	Q54	transistor BC308B	567070
C85	500 mfd, 25v.	280507	D56	silicon diode	544012	Q55	transistor BC237A	577020
C86	250 mfd, 25v.	280257	D57	silicon diode	544012	Q56	transistor BC308B	567070
C87	5 mfd, 15v.	283505	D58	silicon diode	544012	Q57	transistor BC237A	577020
C101	.01 mfd, 100v., 20%	234103	D59	zener diode	540014	Q58	transistor BC237A	577020
C102	.01 mfd, 100v., 20%	234103	D60	zener diode	540113	Q59	transistor BC237A	577020
C103	.1 mfd, 25v.	223104	D101	germanium diode	543541	Q60	transistor D40D2	574001
C104	.1 mfd, 25v.	223104	D102	germanium diode	543541	Q101	transistor BC308B	567070
C105	.01 mfd, 100v., 20%	234103	D103	zener diode	540113	Q102	transistor BC237A	577020
C106	.01 mfd, 100v., 20%	234103	D104	silicon dual diode	546361	Q103	transistor BC237A	577020
C107	.1 mfd, 25v.	223104	D105	germanium diode	543541	Q104	transistor BC237A	577020
C108	.1 mfd, 25v.	223104	D106	silicon diode	543148	Q105	transistor BC237A	577020
C109	.22 mfd, 25v.	222224	D107	silicon diode	543148	Q106	transistor BC237A	577020
C110	500 pf	245501	D108	silicon diode	543148	Q107	transistor BC237A	577020
C111	47 pf, 20%	244472	FE201	front end	553666	Q108	transistor BC308B	567070
C112	.1 mfd, 25v.	223104	FL1	4-pole ceramic filter	505107	Q109	transistor BC308B	567070
C113	.1 mfd, 25v.	223104	FL2	4-pole ceramic filter	505107	S201	DPTT rocker switch	337001
C114	50 mfd, 10v., non-pol.	282506	FL51	phase comp. filter	420122	S202	TPTT rocker switch	334033
C115	.001 mfd, 100v., 10%	240102	FL52	67 kHz filter	420022	S203	QPDT rocker switch	334042
C116	.1 mfd, 25v.	223104	FL53	19 kHz filter	420100	T1	ratio detector	432022
C117	5 mfd, 15v.	283505	FL54	19 kHz filter	420100	T201	power transformer	464122
C118	150 pf, 100v., 10%	238151	FL101	455 kHz filter	420455	T202	RF balun	414022
C119	.1 mfd, 25v.	223104	IC1	IC LM703L	587010			
C120	.022 mfd, 100v., 10%	264223	IC2	IC LM703L	587010			
C121	.047 mfd, 100v., 5%	264473	IC3	IC CA3012	587012			
C122	.047 mfd, 100v., 5%	264473						
C123	.047 mfd, 100v., 5%	264473						
C124	.33 mfd, 100v., 10%	264334						

- 48 ( ) Prepare a 2½" red wire. Connect one end to the back of eyelet #2. (S).
- 49 ( ) Prepare a 2½" black wire. Connect one end to the back of eyelet #3. (S).
- 50 ( ) Prepare a 4½" black wire. Connect one end to the back of eyelet #7. (S).
- 51 ( ) Prepare a 6" green wire. Connect one end to the back of eyelet #10. (S).
- 52 ( ) Select the 4½" (shortest) length of prepared shielded coaxial cable on which the ends have already been tinned. On one end, part of the shield strands had been removed. Connect this shield end (be careful of excess heat) to the back of eyelet #13. (S). Connect the center conductor to the back of eyelet #11. (S). Note that these are *not* adjacent eyelets!
- 53 ( ) Prepare a 5" red wire. This wire, and the one in the next step, will be connected to the *front* side of the circuit board. Connect one end of this wire to eyelet #8. (S).
- 54 ( ) Prepare a 1¾" black wire. Connect one end to the *front* of eyelet #12. (S).

Temporarily bend these wires across the face of the board towards the opposite edge, and set PC-25 board aside.

- 55 ( ) Select the PC-26 (longest) circuit board, two brackets, and four sets of #4 hardware. Add more solder to the eyelets if necessary, as for the previous board. Mount the brackets as before on the back side of the board, and support the board so that wires may be connected to the back.

Note that the eyelets on the PC-26 are close together in some cases where adjacent eyelets represent the same circuit connection. Because of space limitations, a couple of the eyelets are not separately identified on the front of the board, but they are all in sequence.

- 56 ( ) Prepare a 6" red wire, but remove ½" of insulation from one end. Connect the *shorter* end to the back of eyelet #20. (S).
- 57 ( ) Prepare an 8" green wire, but remove ½" of insulation from one end. Connect the shorter end to the back of eyelet #22. (S).
- 58 ( ) Prepare a 5½" black wire. Connect one end to the back of eyelet #5. (S). Connect the other end to the back of eyelet #23. (S).

Temporarily bend the two wires across the face of the board towards the opposite edge, and set the PC-26 aside.

- 59 ( ) Select the PC-27 circuit board, the remaining brackets, and four sets of #4 hardware. Add more solder to the eyelets if necessary. Mount the brackets as before on the back side of the board, and support the board so that wires may be connected to the back.

On this board a lack of space requires that all the eyelets be spaced very closely, and only a few are identified by number on the front. Note particularly that eyelet 4 is *above* eyelet 3 (they are joined) and that eyelets 10, 11 and 12 are the only other eyelets joined together, so you must be particularly careful that solder bridges do not short between eyelets.

- 60 ( ) Prepare a 5" black wire. Connect one end to the back of eyelet #12. (S). Connect the other end to the back of eyelet #17. (S).
- 61 ( ) Prepare a 4¾" red wire. Connect one end to the back of eyelet #10. (S).
- 62 ( ) Prepare a 5" black wire but remove ½" of insulation from one end. Connect the shorter end to the back of eyelet #8. (S).
- 63 ( ) Prepare a 6" black wire. Connect one end to the back of eyelet #7. (S).
- 64 ( ) Prepare a 3" red wire. Connect one end to the back of eyelet #4. (S).
- 65 ( ) Prepare a 5¼" green wire. Connect one end to the back of eyelet #3. (S).
- 66 ( ) Prepare a 10" black wire. This wire, and those in the next two steps, will be connected to the *front* side of the circuit board. Connect one end of this wire to eyelet #6. (S).
- 67 ( ) Prepare an 8" green wire. Connect one end to the front of eyelet #16. (S).
- 68 ( ) Select the remaining length of prepared shielded coaxial cable on which the ends have already been tinned. On one end, part of the shield strands had been removed. Connect this shield end (be careful of excessive heat) to the *front* of eyelet #13. (S). Connect the center conductor to the front of eyelet #14. (S).

Set the PC-27 to one side and place the main chassis plate before you, with the transformer near you on the right. Select the front panel assembly and unfold all of the wires which had previously been tucked underneath the panel. They should all be straightened so that they point directly away from the panel. Place the panel upright at the front of the chassis.

### Completing the Wiring

- 1 ( ) Select four #6 sheet metal screws and fasten the front panel assembly to the chassis plate. The sheet metal screws are always hard to install the first time, because the holes in the second piece of metal must be undersized to allow the screws to grip tightly for a rigid chassis assembly. Be sure these screws are pulled up fully.
- 2 ( ) Now "tin" the ends of each of the unattached wires on the chassis. This will facilitate a good connection to each eyelet.
- 3 ( ) Check each of the connections on the front panel for a good smooth solder connection, and make sure that none of the bare wire jumpers (3 on DS, one each on the other switches) touch other than their intended terminals.

- 4 ( ) Lay the PC-27 board, components side facing down, on top of the wires from the switches, with the eyelets towards the front panel. The wires from the volume control should be placed near the transformer, out of the way. Lift above the board the following wires:
- black wire from AS lug 4
  - green wire from AS lug 1
  - red and green twisted pair from AS
  - black wire from MS lug 3
  - red wire from MS lug 4
- The remaining wires from the switches should be carefully bent (try not to disturb the lugs) down so that they are against the chassis under the circuit boards.
- 5 ( ) Select the black wire from MS lug 3 and connect it to PC-27 eyelet #1. (S).
- 6 ( ) Select the red wire from MS lug 4 and connect it to PC-27 eyelet #2. (S).
- 7 ( ) Select the green wire from AS lug 1 and connect it to PC-27 eyelet #5. (S).
- 8 ( ) Select the red and green twisted pair from switch AS. Connect the red wire to PC-27 eyelet #9. (S). Connect the green wire to PC-27 eyelet #11. (S).
- 9 ( ) Select the black wire from AS lug 4 and connect it to PC-27 eyelet #15. (S). Now recheck all of the eyelets for secure connections.
- 10 ( ) Select two sets of #4 hardware. Stand the PC-27 upright and allow the 7 single wires and the twisted pair to pass under the board to the rear of the chassis. Fasten the brackets to the chassis. It will make future connections easier if you observe the sequence of these wires on the diagram and put them in that order under PC-27 before you tighten the mounting bolts.
- 11 ( ) Lay the PC-25 board, components side facing down, on top of the wires protruding under PC-27, with the eyelets toward the PC-27 board. Place the following wires under PC-25:
- green wire from PC-27 eyelet 3
  - black wire from PC-27 eyelet 7
  - red wire from PC-27 eyelet 10
- Lift the following wires above PC-25:
- green wire from DS lug 7
  - red wire from AS lug 6
- 12 ( ) Select the red wire from eyelet 4 on PC-27 and connect it to PC-25 eyelet #4. (S).
- 13 ( ) Select the red wire from AS lug 6 and connect it to PC-25 eyelet #5. (S).
- 14 ( ) Select the green wire from DS lug 7 and connect it to PC-25 eyelet #6. (S).
- 15 ( ) Select the black wire from PC-27 eyelet 8. This wire is the shortest black wire, and has  $\frac{1}{2}$ " of bared tinned conductor exposed. Connect it to PC-25 eyelet #9, but leave  $\frac{1}{4}$ " of bare wire showing on the front of PC-25.
- 16 ( ) Select the remaining .01 mfd disc capacitor and trim each lead to  $\frac{1}{4}$ ". Form a hook in one lead, and connect that lead to the exposed wire on the black connection to PC-25 eyelet 9. (S). The other end is not yet to be connected. Now check all of the eyelets for secure connections.
- 17 ( ) Select two sets of #4 hardware. Stand the PC-25 upright and allow the 8 single wires and the twisted pair to pass under the board and to the rear of the chassis to the left of the chassis ground lug. Fasten the brackets to the chassis.
- 18 ( ) Connect the free end of the .01 mfd disc capacitor on PC-25 eyelet 9 to the ground lug on the chassis. (S).
- 19 ( ) Lay the PC-26 board, components side facing down, at the rear of the chassis with the eyelets toward the PC-25 board. Lift all of the wires above the board. Some of these wires may appear long, but eventually they should all be positioned to pass under the PC-25 board between eyelets 1 and 6.
- In the following steps all connections will be made to eyelets on the PC-26 board.
- 20 ( ) Position the long black wire from DS lug #1 under all of the other wires, and connect it to eyelet #24. (S).
- 21 ( ) Connect the red wire from PC-25 eyelet 2 to eyelet #1. (S).
- 22 ( ) Connect the green wire from DS lug 8 to eyelet #2. (S).
- 23 ( ) Connect the red wire from PC-27 eyelet 10 to eyelet #4. (S).
- 24 ( ) Connect the black wire from PC-25 eyelet 3 to eyelet #6. (S).
- 25 ( ) Connect the green wire from PC-27 eyelet 3 to eyelet #7. (S).
- 26 ( ) Connect the black wire from DS lug 4 to eyelet #8. (S).
- 27 ( ) Connect the green wire from MS lug 8 to eyelet #10. (S).
- 28 ( ) Connect the red wire from DS lug 6 to eyelet #13. (S).
- 29 ( ) Connect the black wire from PC-27 eyelet 7 to eyelet #15. (S).
- 30 ( ) Select the black and green twisted pair from switch AS. Connect the black wire to eyelet #18. (S). Connect the green wire to eyelet #19. (S).
- 31 ( ) Connect the black wire from PC-25 eyelet 7 to eyelet #25. (S).
- 32 ( ) Select the green and red twisted pair from the volume control. Connect the green wire to eyelet #16. (S). Connect the red wire to eyelet #17. (S).
- 33 ( ) Connect the black wire from the volume control to eyelet #21. (S).

In connecting the transformer leads which are stranded wires, it is important that all the strands are first "tinned" so that they will all be inserted into the eyelet as a unit, thus avoiding problems from stray strands. *Always heat the eyelet first* until its solder melts, and then insert the stranded wire lead. In this way the strands of the cold lead will not splay apart when they first contact the eyelet, but will pass through it as a unit. You may wish to shorten the leads as supplied, but be careful you do not cut the leads too short, or nick the wire in stripping it.

- 34 ( ) Connect the blue transformer lead to eyelet #26. (S).
- 35 ( ) Connect the green transformer lead to eyelet #29. (S).
- 36 ( ) Connect the red transformer lead to eyelet #30. (S).
- 37 ( ) Select the two indicator lamps. Install the one with the red lead in the bottom blue lamp cover on the front panel. Install the one with the white lead in the top blue cover. Push each lamp all the way into the cover, which is a snug fit. Twist the ends of the two blue leads together, and "tin" them so as to form a single unit for easier insertion into eyelet #28 of PC-26. Heat the eyelet until its solder melts, and insert the pair. (S-2).
- 38 ( ) "Tin" the end of the red lead from the lower indicator lamp on the front panel (you may wish to shorten it), heat eyelet #9 of PC-26 until the solder melts, and insert the lead. (S).
- 39 ( ) "Tin" the end of the white lead from the upper indicator lamp on the front panel, heat eyelet #3 of PC-26 until the solder melts, and insert the lead. (S). Now check all of the eyelets on PC-26 closely for proper solder connections.
- 40 ( ) Select two sets of #4 hardware. Stand the PC-26 board upright and secure the brackets to the chassis.
- 41 ( ) Connect the gray transformer lead to lug #2 (the grounded lug) of the 3-lug terminal strip. (S). You can shorten the transformer leads if desired.
- 42 ( ) Connect the white transformer lead to lug #3 of the 3-lug terminal strip.
- 43 ( ) Prepare a 10½" green wire. Connect one end to lug #3 of the 3-lug terminal strip. (S-2). Connect the other end to the lower lug #4 of the right lamp holder on the front panel. (S-2).
- 44 ( ) Select the back panel assembly, and two #6 sheet metal screws. Place the back panel in position, and insert the screws only in the corner hole at each end. Do not tighten the screws excessively to allow the panel to be tilted outwards for working.
- 45 ( ) Connect the red wire from the volume control switch lug 7 to AC outlet lug #2.

- 46 ( ) Twist together the black and the black and white transformer leads, and connect them both to side lug #2 of the fuse holder. (S-2).

NOTE: If this unit is obtained in Canada, twist together the black and the black and white transformer leads and connect them to lug #1 of the 3-lug terminal strip. (Do not solder).

NOTE: If this unit is to be used with a 240 volt AC line, connect only the black lead to lug #2 of the fuse holder. (S). Connect the black and white lead to lug #1 of the 3-lug terminal strip.

- 47 ( ) Twist together the violet and violet and white transformer leads and connect them both to AC outlet lug #2. (S-3).

NOTE: If this unit is to be used with a 240 volt AC line connect only the violet lead to lug #2 of the AC outlet. (S-2). Connect the violet and white lead to lug #1 of the 3-lug terminal strip. (S-2).

- 48 ( ) Twist tightly together the strands at the free end of the AC line cord and "tin" them. Connect this end to volume control lug #8. (S-2). Be certain that all of the strands of wire are soldered to this lug, and that there is no possibility for any of them to touch the outer casing of the control.

- 49 ( ) Thread the red wire from PC-26 eyelet 20 through the long audio output socket lug #2 and connect it to lug #1. Solder both lugs.

- 50 ( ) Thread the green wire from PC-26 eyelet 22 through the long audio output socket lug #4 and connect it to lug #3. Solder both lugs.

- 51 ( ) Select two #6 sheet metal screws. Tilt the back panel into its upright position and secure it with the two screws. Tighten all four screws. Be sure the screws near the transformer do not cut the insulation on the wiring.

- 52 ( ) Insert the fuse into the fuse holder on the back panel.

NOTE: If this unit is obtained in Canada, the fuse holder cap will be cemented in place. Select the pigtail fuse and the insulating sleeving. Trim each fuse lead to ¾" and slip ½" of the sleeving onto each lead. Connect one lead to lug #1 of the 3-lug terminal strip. (S-3). Connect the other lead to the fuseholder tip lug #1. (S-3).

Now place the front end assembly in position on the chassis, with the pulley at the outer edge. Handle it with great care so as not to disturb any component adjustments. There are 3 transistors, each having 3 leads, located on its circuit board adjacent to the square metal cans. Check to be sure that none of these leads can touch adjacent leads.

In making connections to the front end, you must refer to the diagram for the location of the unmarked terminals. Be certain you connect to the right points. Do not disturb the placement of any components already in position. Connecting wires must be wrapped around terminals 1 through 7. Terminals 9 through 14 are solder-filled loops. Just melt the solder and push the tinned lead through.

- 53 ( ) Select 4 sets of #6 hardware and secure the front end assembly.
- 54 ( ) Connect the short black wire from PC-25 eyelet 12 to the adjacent ground lug on the front end. (S).
- 55 ( ) Prepare a 2¼" black wire. Connect one end to front end terminal #1. (S). Connect the other end to front end terminal #3.
- 56 ( ) Connect the green wire from PC-27 eyelet 16 to front end terminal #7. (S). Place this wire along the chassis.
- 57 ( ) Connect the black wire from PC-27 eyelet 6 to front end terminal #4. (S). Place this wire along the chassis.
- 58 ( ) Select the shielded cable from PC-27. Connect the shield to front end terminal #3. (S-2). Watch excessive heat! Connect the center conductor to terminal #2. (S).
- 59 ( ) Connect the red wire from PC-25 eyelet 8 to front end terminal #9. (S).
- 60 ( ) Select the shielded cable from PC-25. Connect the shield to front end terminal #11. (S). Watch excessive heat! Connect the center conductor to terminal #10. (S).
- 61 ( ) Connect the green wire from PC-25 eyelet 10 to front end terminal #12. (S). There are already a number of connections soldered to this terminal. A short piece of bare wire protrudes, to which the green wire can be connected. Be sure the connection is correct. Place the wire along the chassis.
- 62 ( ) Select the shielded cable from the (lower) 4-screw terminal strip on the back panel. Connect the shield to front end terminal #14. (S). Watch excessive heat! Connect the center conductor to terminal #13. (S). Check *very carefully* to be sure no stray shield strands can touch adjacent terminals.
- 63 ( ) The stiff piece of wire from lug #4 of the 4-lug terminal strip is to be kept straight, and as far above the front end as its length permits. Directly above front end terminal #8, make a right angle downward bend in this wire. Note that terminal #8 is to the right of the 8-lug terminal strip. Place ⅛" of the end of the wire against the #8 lug (the stiffness of the wire should hold it in position for soldering) and solder this connection. The reason this wire is stiff is to maintain its position after the AM trimmer capacitor has been precisely tuned.
- 64 ( ) Select the shielded cable from the 4-lug terminal strip. Connect the shield to front end terminal #6 (S). Watch excessive heat! Connect the center conductor to terminal #5. (S). Be careful of adjacent components. Be certain that no stray shield strands can touch any other leads to components on the circuit board.

This completes the wiring of your Dynatuner. You should check carefully for any insecure connections, and for any possibility of bare wires contacting other than the intended terminal. Turn the unit upside down and shake out any bits of solder or pieces of wire or insulation. The general placement of wires should conform to the photograph of the inside of the chassis. The wires under PC-25 should all pass between eyelet 6 and the edge of the chassis. This keeps them away from critical front end circuitry.

Be certain that the shield strands of the four shielded coaxial cables are clear of any but their intended terminals. They should not touch the chassis, or any metal work.

### Final Assembly

- 1 ( ) Select one of the nylon pulleys and one of the spring steel Tinnerman™ nuts. Slide the pulley onto the brass support on the front end, and then force the nut on with your fingers, *while supporting the bracket from behind*. Slide the nut only ⅛" onto the shaft to allow the pulley plenty of sideways movement.

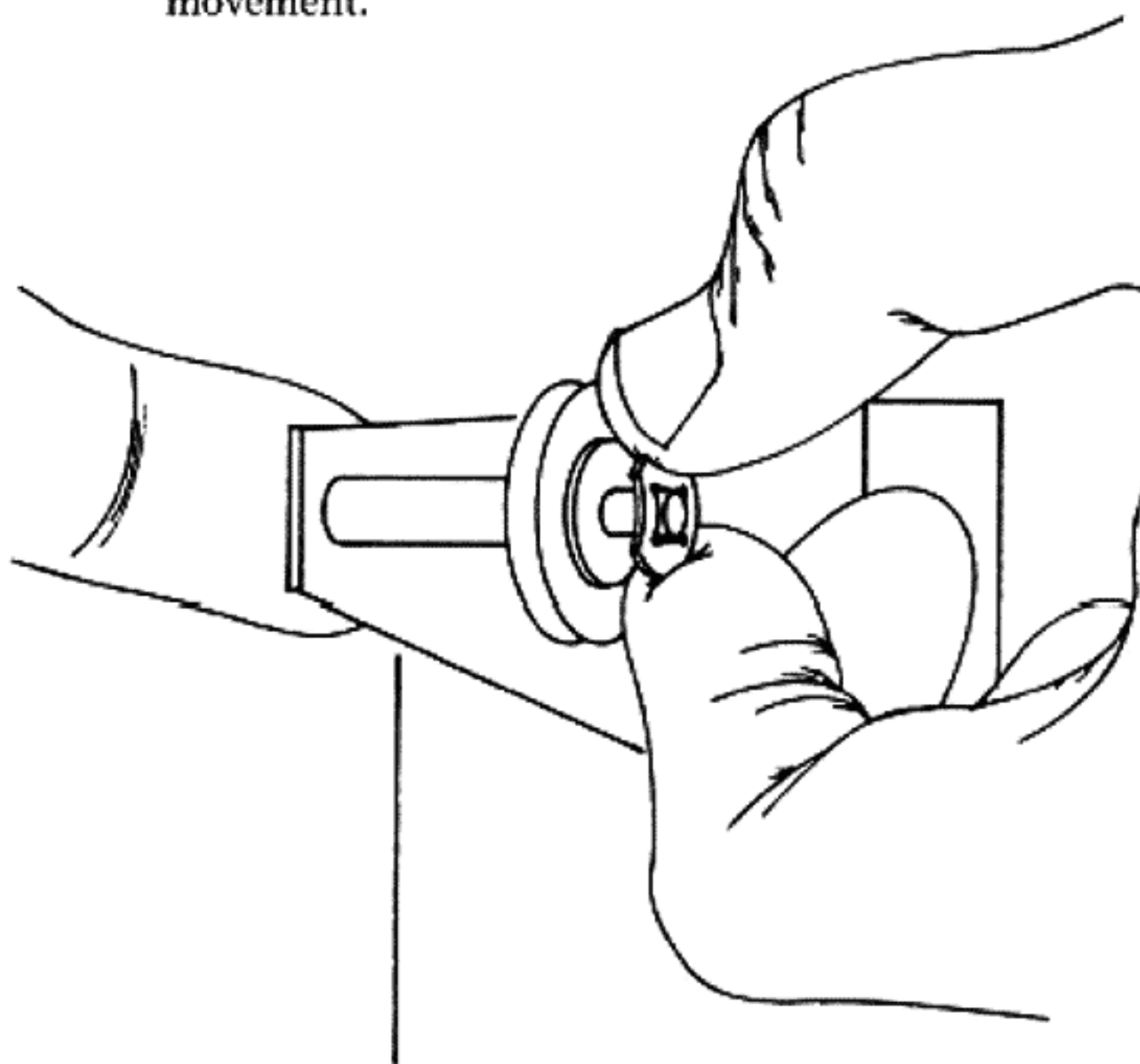

- 2 ( ) Select two of the small fiber washers, two nylon pulleys, and another Tinnerman™ nut. On the brass support adjacent to the meter place one fiber washer, one nylon pulley, another washer and the second pulley. Then *carefully* install the nut (so it does not touch the pulley) with your fingers. The angle of this bracket is critical for proper dial operation, so do not bend it.
- 3 ( ) Select two more washers, the two pulleys, and the Tinnerman™ nut. On the last support at the other end of the panel, install a washer, a pulley, the other washer, the 2nd pulley and the nut. The nut should not touch the pulley.
- 4 ( ) Select the prepared dial cord and spring. Attach the spring to one end of the cord, and hold the cord from the opposite end so that it falls free, to remove any tendency to tangle or twist. You should avoid twisting it during installation for best operation.

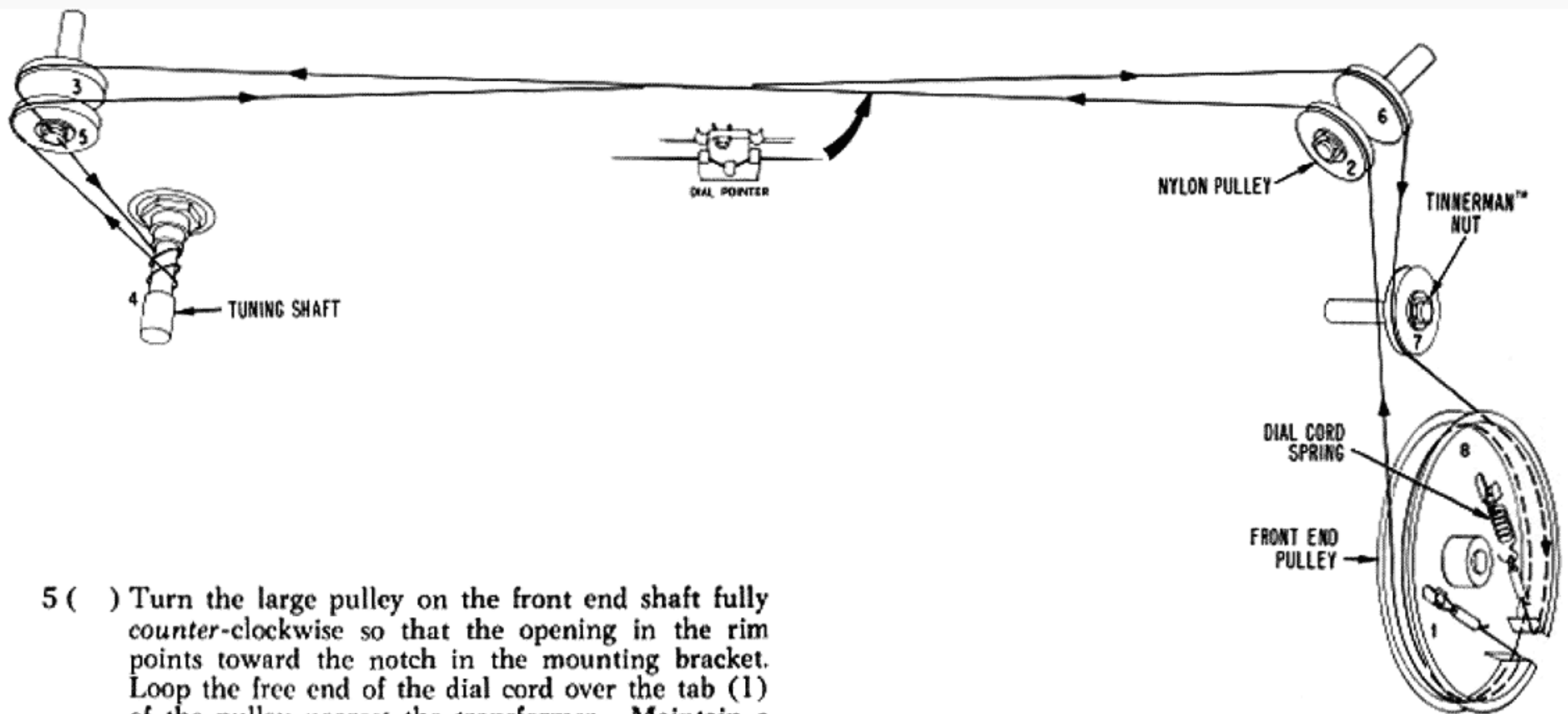

- 5 ( ) Turn the large pulley on the front end shaft fully counter-clockwise so that the opening in the rim points toward the notch in the mounting bracket. Loop the free end of the dial cord over the tab (1) of the pulley nearest the transformer. Maintain a steady slight tension on the cord while you bring it through the opening in the rim, wrap it clockwise one and one-quarter turns around the pulley, and then  $\frac{1}{4}$  turn counterclockwise around the top nylon pulley (2) above the meter. Carry it across the front panel, and over the top of the pulley (3) nearest the panel, and down past the outside of the tuning shaft (4). Take  $2\frac{1}{2}$  complete turns counterclockwise around the tuning shaft, and then bring the cord up on the outside of the rear pulley (5). Carry it clockwise over the top of the pulley, across the front of the tuner, under the other strand, and clockwise around the bottom pulley above the meter (6). Now carry it over the top of the single pulley (7) on the front end bracket, clockwise one quarter turn around the large front end pulley, through the opening in the rim, and secure the spring on the front inside tab (8).

You may find that the dial cord seems short at first. There will be some stretching the first few times the dial is operated. If necessary to avoid deforming the spring, temporarily connect it with a short piece of wire, or reduce the wrap around the tuning shaft to  $1\frac{1}{2}$  turns.

- 6 ( ) With the dial in its original position for stringing and with the pulley opening at the bottom rear, select the dial pointer and slip it over the top of its track. There should be a small amount of fore and aft play in this pointer, but if it is more than  $\frac{1}{8}$ ", you can carefully squeeze its mounting surfaces together. Do not squeeze them too tightly or the tuning mechanism will not run freely. Slide the pointer to within  $\frac{1}{2}$ " of the meter end of the dial and slip the upper strand of the dial cord (from pulley 2 to pulley 3) through the 3 tabs of the pointer to secure it. First place it under the bottom tab, and then snap it over the outer tabs while holding the pointer on the track. This is an approximate position, and if the dial was assembled properly, the pointer should traverse the panel as the tuning shaft is rotated.

- 7 ( ) Select the flywheel in which you have previously installed the two setscrews. Slide the flywheel onto the tuning shaft with the grooved-out side facing the front of the tuner. With its rear surface flush with the end of the shaft, tighten both setscrews.
- 8 ( ) Select the gold front plate, the two  $\frac{3}{8}$ " nuts, and the plastic dial. Although the dial has been treated to resist static charge and fingerprints, handle it lightly, and only by the edges to keep it clear. Install the dial in the cutout on the front panel, place the front plate over it and secure them with  $\frac{3}{8}$ " nuts on the two shafts. If you find that the controls or switches do not clear the cutouts properly, their hardware can be loosened to shift them slightly to correct this.
- 9 ( ) Insert a set screw in each of the knobs if this was not done earlier. Install the large knob on the tuning shaft. The small knob should be installed on the volume control so that the indicator is at 7 o'clock when the control is switched off at the full counterclockwise rotation.
- 10 ( ) Turn the tuning knob until the pointer is at the extreme left of the dial. Align the pointer so that it passes through the "0" index mark to the left of the "88" by holding the dial cord and sliding the pointer along it. The stations should now appear at the proper locations on the dial.
- 11 ( ) Tune to an AM station between 130 and 150 (1300 KHz to 1500 KHz). Tune the station precisely, with the meter reading a maximum. Now adjust the AM antenna trimmer on the front end (see diagram on p. 25) with a screwdriver so that the meter is again giving a maximum indication.
- 12 ( ) Slide the cover over the tuner, and secure it with the 5 sheet metal screws. The 5th one is installed at the center of the back panel.

You may wish to secure the Allen wrench for the set screws with tape either inside or under the chassis.

## AM ALIGNMENT WITHOUT INSTRUMENTS

The AF-6 is easily capable of meeting its specifications when assembled from a kit because of factory prealignment of the circuit boards and front end as a matched set. However, unlike FM, AM circuitry does not always enable prealignment to the maximum capabilities of the system. If AM listening is of particular import, you may wish to verify optimum performance by the following after adjusting the antenna trimmer as indicated at the end of the instructions.

The oscillator transformer and oscillator trimmer capacitor of the front end have been precisely tuned with a frequency counter. Do not change this setting.

1. Locate a fairly weak station at each end of the dial—preferably around 600 kHz and 1400 kHz. Adjust the AM loopstick antenna for best reception.

2. Tune precisely to the lower frequency station. Carefully adjust the RF transformer (green slug) in the metal shield on top of the front end, while watching the meter to obtain the highest possible indication. Then do the same for the IF transformer (white slug).

3. Tune precisely to the higher frequency station. In like manner, while watching the meter, adjust the trimmer capacitors (reached through holes in the front end circuit board): The center (RF) first, and the antenna trimmer last.

4. Repeat steps 2 and 3 in the same order until the relative signal strength is at a maximum for either station.

5. Locate a very loud station near the middle of the dial. Place the audio bandwidth switch in "wide." Compare the level of the AM station with a typical FM station. If necessary, you can adjust the AM level to match that of the FM station with P102 on the PC-27 board.

6. The majority of local AM stations should indicate a meter deflection between 50% and 75% of full scale for easiest tuning. P101 on PC-27 determines the relative meter sensitivity.

Under no circumstances should L102 (the 10 kHz notch filter) be adjusted without instruments. Filter FL101 must never be tampered with.

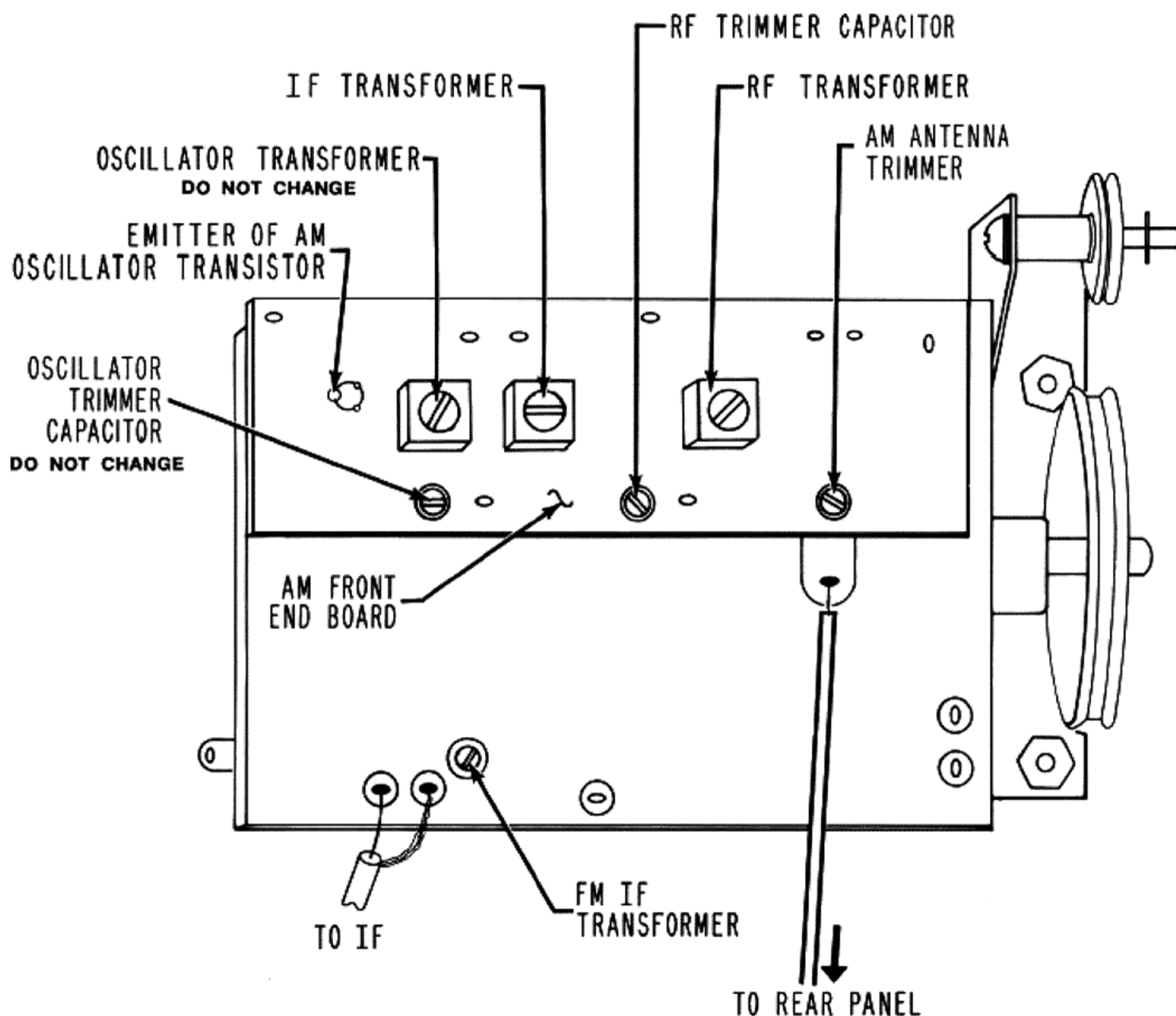



## PROFESSIONAL SERVICE ALIGNMENT

(FOR QUALIFIED PERSONNEL WITH THE PROPER EQUIPMENT ONLY)

### FM ALIGNMENT

There is no provision for any home FM alignment of the AF-6, and under no circumstances should any adjustments be made without the following service equipment:

1. Sound Technology 1000A FM alignment generator, or the equivalent, such as a Measurements Corporation Model 88 or 210A generator, plus a suitable multiplex generator with adjustable pilot level, and an accurate 67 kHz oscillator.
2. Oscilloscope—Hewlett Packard 130C or equivalent with its Diode Probe and a 10:1 Probe.
3. AC voltmeter with rms scale.
4. DC voltmeter, with 0.5 volt or less full scale; 10 megohms input impedance.
5. Intermodulation Analyzer.

Operate both the tuner and the instruments for at least 20 minutes prior to alignment.

#### IF Alignment

Locate a dial setting between stations. Switch the tuner to MONO, DYNATUNE™ OFF, and maximum volume. Tune the generator to the same frequency with 200 kHz deviation and a 3000  $\mu\text{V}$  output. Connect the diode probe to the scope vertical input, with a sensitivity of 10 mv/cm. Set the scope's horizontal external sensitivity for 1 v/cm, with the sweep ("external" or "horizontal") output of the generator connected to the horizontal input.

The diode probe connected to TP 1 of PC-25 will show tuning as a bandpass curve. Center the curve on the scope display with the tuning knob. The IF transformer is the *only* adjustment on the FM section of the front end. Adjust both slugs from the top, seeking the best combination of symmetry and amplitude.

#### Detector

Reduce the sweep to 75 kHz, but be careful not to touch the tuning of either the generator or the AF-6. Connect the DC voltmeter (on its most sensitive scale) to the tuner chassis and to eyelet #4 on PC-25. Adjust the secondary (top) of the detector transformer T 1 for zero. Disconnect the diode probe. Switch the generator to external modulation and connect the IM analyzer to it. The IM signal should be in a 1:1 ratio to allow for de-emphasis. Adjust the IM analyzer level to 100% modulation as indicated on a peak reading modulation meter like the model 1000A. Connect the tuner output to the IM analyzer. Adjust the primary (bottom) of the detector transformer for minimum IM. Remove IM analyzer.

**Service Note:** The TUNED indicator lamp is a part of the muting circuit. If it is *shorted* for an extended period, the audio will remain muted, even on a station. Switching the muting *off* will enable signal reception until the lamp is replaced. If the lamp is *open*, the muting circuit will not work and there will be noise between stations in all switch positions.

#### Audio Level

Maintain 3000  $\mu\text{V}$  signal level and switch to 400 Hz modulation. Adjust trimpot P 4 on PC-25 for 2 volts audio output from tuner with the volume control fully up.

#### Muting Threshold

Switch to MUTE, attenuate the generator output to 8  $\mu\text{V}$  (assuming the use of a 2:1 balun), and adjust trimpot P 52 on PC-26 until the audio just mutes off. Adjust trimpot P 52 until audio just comes on (actually 4  $\mu\text{V}$ ).

#### Dynatune

Return the generator to 3000  $\mu\text{V}$ . Connect the DC probe to eyelet #1 on PC-25. Retune for zero if necessary. Then switch the mute switch to DYNATUNE™. If the zero indication changes *at all*, adjust trimpot P 3 on PC-25 for zero.

#### 67 kHz Filtering

From an external oscillator connect an *accurate* 67 kHz source to the external modulation input of the FM generator. Connect the 10:1 probe to the negative side (the top end) of C 51. While observing the 67 kHz on the scope, adjust filter FL 52 for minimum amplitude.

#### Multiplex

Switch to STEREO. Connect the stereo generator to the external input of the FM generator. Connect the 10:1 probe to the vertical input of the scope, and set the internal sweep to approximately 2 milliseconds/cm. Connect the probe to eyelet #11 on PC-26. Peak both the 19 kHz coils L 52 and L 53 for maximum vertical deflection. Go back and forth.

Reduce the pilot level on the multiplex generator to 5%. Adjust trimpot P 51 until the STEREO light goes out. Then adjust trimpot P 51 until the STEREO light just comes on. The STEREO light should come on at 5% of the total modulation. Return pilot level at generator to 10%. Move the probe to eyelet #12 on PC-26 and adjust the 38 kHz coil L 54 for maximum vertical deflection. Remove probe.

With 1 kHz modulation on the left channel only, observe the right channel output and adjust first the 38 kHz coil L 54 and then the 19 kHz coil L 53 for minimum indication (maximum separation). Compare left and right separation. Switch to 10 kHz modulation on the left channel and adjust filter FL 51 for minimum indication (maximum separation).

#### Meter Adjustment

Switch to MONO and decrease FM generator output to 10  $\mu\text{V}$ . Set trimpot P 1 on PC-25 for 25% meter deflection. Increase the FM output to 30,000  $\mu\text{V}$ . Set trimpot P 2 for full scale meter deflection.

## PROFESSIONAL SERVICE ALIGNMENT

(FOR QUALIFIED PERSONNEL WITH THE PROPER EQUIPMENT ONLY)

### AM ALIGNMENT

The following equipment is required for complete alignment of the AM section:

1. AC voltmeter having an input impedance of 1 megohm or greater, and full scale deflection at 10 mv or less.
2. DC voltmeter having an input impedance of 1 megohm or greater, and full scale deflection at 0.3 volt.
3. AM generator having less than 10% THD at 30% modulation at 400 Hz and 10 kHz with 5 mv output.
4. Audio oscillator.
5. Oscilloscope.
6. Digital Counter with a sensitivity of less than 80 mv, and input impedance of 1 megohm or greater shunted by less than 10 pf; range to 2 MHz.

The oscilloscope and digital counter are not mandatory. The scope simply provides visual monitoring of the signal. The counter provides the only truly exact means of alignment. If one is not available, however, the front end may be aligned with just the generator's 400 Hz, 5 mv signal at 30% modulation, following the procedure indicated under "AM Alignment Without Instruments."

Operate both the tuner and the instruments for at least 20 minutes prior to alignment.

#### AM Front End and IF

Check for proper zeroing of dial pointer at extreme left of traverse, and then tune to 600 kHz. AM generator output should be 5 mv at 30% modulation. Connect the counter to the emitter of the AM local oscillator transistor. Adjust the red slug on the oscillator transformer for a counter indication of 1.055 MHz. Tune to 1400 kHz and adjust the oscillator trimmer capacitor for a counter indication of 1.855 MHz. Repeat these adjustments alternately.

Connect the AM generator through a 200 pf capacitor, or a standard dummy antenna network to the AM external antenna terminal and ground. Modulate the generator at 600 kHz with a 400 Hz sine wave, and tune the AF-6 for an oscillator frequency of 1.055 MHz (600 kHz on the dial). Measure the AGC DC voltage at eyelet 16 of PC-27, and adjust the RF transformer (green slug) and IF transformer (white slug) for the best null (which will be between 0.3 and 1 volt). Tune to 1400 kHz on the dial (1.855 MHz on the counter) with the AM generator at the same modulation, and adjust the antenna trimmer and RF trimmer capacitors for the best null. Repeat these adjustments alternately. Remove voltmeter and counter.

#### Audio Level

Tune the AF-6 and the AM generator to 1000 kHz, with a 5 mv input of a 400 Hz sine wave at 30% modulation. Switch to medium audio bandwidth. Connect the AC voltmeter and oscilloscope to the output. Adjust P 102 for 0.5 volts rms. with maximum volume setting.

#### 10 kHz Notch Filter

Change the modulation of the generator to 4 kHz. With the AF-6 still tuned to 1000 kHz on the dial, rock the tuning knob back and forth to obtain a minimum output to ensure tuning to the exact center of channel. Change the modulation of the generator to 10 kHz. The output level should now be at least 40 dB below the 0.5 volt reference level. If it is not, and 10 kHz appears in the output, adjust L 102 for minimum. Note: by tailoring the value of R 130 and adjusting L 102 a notch greater than 65 dB may be obtained, but a wave analyzer or selective voltmeter is then needed for monitoring the output.

#### Meter Adjustment

Adjust P 101 for a nominal meter deflection of 50% to 75% for most stations.

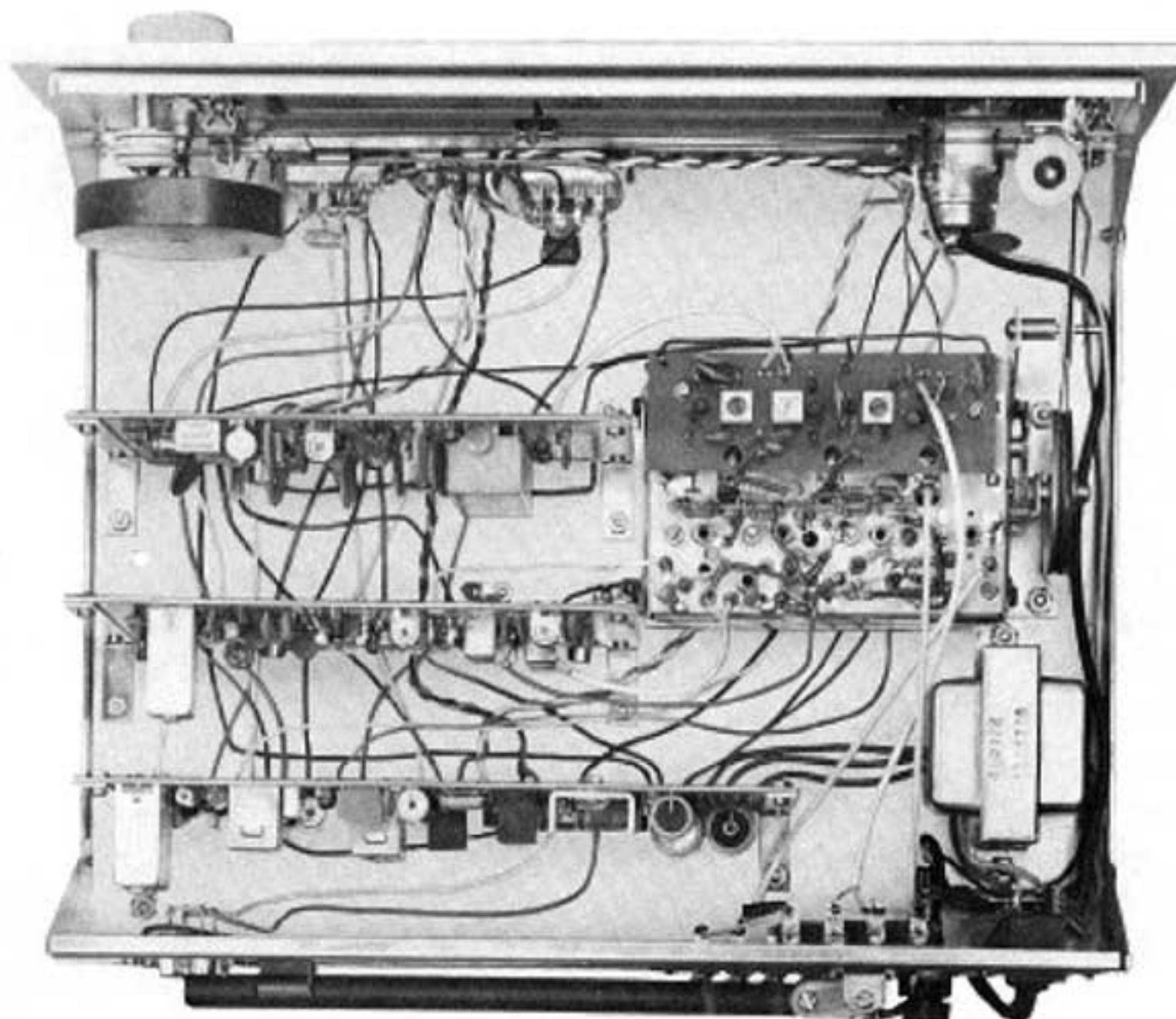

## SERVICE POLICY AND LIMITED WARRANTY

The AF-6 has been carefully engineered to provide many years of musical enjoyment without difficulty. Each factory-assembled AF-6 has been subjected to a full complement of performance tests prior to shipment. Every AF-6 circuit board and front end in the kit has been tested and aligned in operation as a fully functioning unit to verify its performance capability. Nevertheless, through damage in transit, faulty kit assembly, or human error, service may sometimes be required.

To provide rapid and reliable service, Dynaco has authorized competent, well-equipped service facilities in several localities in the United States and Canada, in addition to its service facility at the factory. These stations are authorized to make repairs in and out of warranty under the terms listed below. Service is always available at the factory, but you will often find a more convenient facility locally. Write to Dynaco for the name of the service station nearest you.

It is the owner's responsibility to take or send the unit freight prepaid to the service facility. In the event that you incorrectly diagnose which unit is faulty, please understand that you will be responsible for a check-out charge on any properly performing kit or factory-assembled unit submitted for testing.

Shipment should be made via United Parcel Service or Bus Package Express (or CN or CP Express in Canada) wherever possible. REA Express is an alternative (sometimes Air rates are lower than surface rates). **DO NOT USE PARCEL POST FOR IT IS NOT A SAFE METHOD OF SHIPPING ELECTRONIC EQUIPMENT.** Neither the factory nor the service stations have the facilities to process Parcel Post claims, so should damage occur due to Parcel Post shipment, any broken or damaged parts will be replaced at the owner's expense at net prices.

Always pack the unit properly in the original carton with all the protective inserts, and preferably in the plastic bag. If the carton is not available, the unit should be double-packed with adequate cushioning material between the cartons. Insure it for the full factory-assembled value. You may, if you wish, remove the flywheel to minimize the risk of damage in transit.

Include with the returned unit the following information: 1) Your name and complete shipping address (Post Office box numbers are not suitable); 2) the serial number (from the cover of this manual), *together with a copy of your dated bill of sale*; 3) the symptoms, complete, but preferably brief. If the problem is intermittent, this *must* be noted.

Warranties apply to the original purchaser only; they are not transferable. They do not apply to units which have been physically or electrically abused, or to units which have been modified without prior factory authorization. The use of non-Dynaco replacement parts may in some instances void the warranty. If you suspect a defect in the power transformer, the leads must be unsoldered, not cut for its return. The warranty on the transformer is void if the leads have been cut too short for re-use.

Dynaco maintains a Technical Services Department to help you locate the source of, and possibly correct a problem yourself. You may write or telephone. When writing, mention the serial number of the AF-6, describe the antenna you are using, and any tests you have performed.

Optimum tuner performance depends on its accurate alignment, and such alignment can be performed only with a full set of test equipment as specified elsewhere in this manual. Thus the need to replace any components on either circuit board incurs some doubt as to the tuner's ability to meet its full specifications. The factory may be able to tell you if it deems advisable the return of the complete unit for alignment, if you indicate whatever parts you find to be in need of replacement. *The return of a single circuit board is inadequate to assure proper alignment, and a single circuit board submitted for repair will be returned unserviced.*

### WARRANTY FOR FACTORY ASSEMBLED UNITS

The AF-6 is warranted for a full year from the purchase date, including parts and labor and shipment costs from the service facility to the owner (within the U.S. or Canada). The owner is responsible for shipment to the service facility, and must submit a copy of the dated bill of sale. A 90 day warranty is provided on the service work performed, including shipment both ways, labor and parts.

### WARRANTY FOR KIT-BUILT UNITS

The components in an AF-6 kit are warranted for a full year from the purchase date. If a defective component is found in a completed circuit board, module, or kit, simply return that individual part to the *factory* prepaid, and it will be replaced at no charge. Local service stations are not obligated to supply separate parts.

If you cannot locate the source of the difficulty, ship the entire AF-6 to the nearest authorized service station or to the factory for service. In-warranty parts will be replaced at no charge, although a nominal service fee will be charged for the labor to diagnose, correct, and test the unit to ensure that it meets factory specifications. Shipping charges to and from the service facility are the owner's responsibility. Units will be returned on a COD basis via UPS wherever possible. A 90 day warranty is provided on the service work performed, including shipment both ways, labor and parts.

This warranty is void if the kit has not been completely assembled, or if other than rosin core solder has been used. Units assembled with acid core solder or paste flux will be returned unserviced.

### SERVICE BEYOND THE WARRANTY PERIOD

Dynaco establishes maximum labor fees which may be charged by its service facilities (plus the cost of parts, and shipping charges) without prior approval by the owner. A current list of authorized service stations, and the current established fee for any unit will be supplied on request. Dynaco cannot assume responsibility for service at other than Dynaco authorized service stations.

Dynaco reserves the right to limit the service facility or the established fees to two years from the date of purchase. Dynaco assumes no liability or responsibility for damages or injuries sustained in the assembly or operation of this equipment.

## KIT PARTS LIST

	PART #		PART #
1 Chassis bottom plate	711261	<i>Hardware Envelope</i>	
1 Chassis front panel	711322	1 Cable clamp, plastic	895101
1 Chassis back panel	711263	1 Feedthrough, plastic, 1/4" diameter	895005
1 Chassis sub-panel (black front)	711722	4 Foot, rubber	859001
1 Circuit board assembly, PC-25	957025	1 Fuse, 1/10 ampere slo-blo	342101
1 Circuit board assembly, PC-26	957026	1 Fuse, 1/10 ampere slo-blo pigtail (Canada only)	342102
1 Circuit board assembly, PC-27	957027	7 Ground lug	639308
1 Cover	711027	2 Locknut, #4-40, plastic insert	615245
1 Front End assembly	553666	53 Lockwasher, #6	617305
1 Front plate—gold	769026	2 Lockwasher, 3/8"	617065
1 Transformer, power	464122	41 Nut, hexagonal, #4-40	614245
1 Transformer, power (Canada only)	464123	10 Nut, hexagonal, #6-32	614355
		4 Nut, hexagonal, 3/8"	614065
		3 Nut, spring steel Tinnerman™	717013
1 AC outlet	351001	6 Screw, machine, #4-40 x 3/4"	611205
1 Antenna, twinlead FM dipole	312316	2 Screw, machine, #4-40 x 5/16"	611255
1 Antenna, tubular AM loopstick	414001	37 Screw, machine, #4-40 x 1/4"	611245
6 Bracket, circuit board, L-shape	710422	13 Screw, machine, #6-32 x 5/16"	611355
1 Bracket, lamp holder, T-shape	710126	4 Screw, self-tapping, #6 blue	613345
1 Bracket, front end, two feet	717261	17 Screw, sheet metal, #6	612339
1 Bracket, front end and pulley	717262	5 Set Screw, 3/16" Allen head	613834
1 Bracket, antenna, U-shape, chassis mount	717263	4 Spacer, tubular aluminum	660261
1 Bracket, antenna, U-shape, antenna mount	717264	1 Strain relief, plastic, black	895001
2 Cable, audio connecting	321072	4 Washer, fiber	876022
1 Cable, coaxial shielded, 30"	320187	1 Wrench, Allen #5	968522
1 Dial plate, plastic	844026		
1 Flywheel	715022	<i>Small Parts Box</i>	
		1 Antenna clip, plastic, black	894002
1 Fuse holder, with hardware	341001	1 Antenna coil, balun, tubular	414022
1 Knob, small	764185	1 Capacitor, .01 mfd small disc	234103
1 Knob, large	764184	1 Capacitor, .01 mfd, 1000v. disc	228103
2 Lamp holder, clip type	376022	1 Capacitor, .02 mfd disc	227203
1 Line cord	322092	1 Capacitor, .01 mfd, 250v., mylar, 5%	265103
1 Pulley, front end, 2" diameter	717260	1 Capacitor, 180 pf, disc	224181
2 Socket strip, audio, 2 outputs	355002	1 Capacitor, .0082 mfd, mylar, 5%	264822
1 Switch, rocker, DPTT (8 lugs)	337001	1 Capacitor, 1.0 mfd electrolytic	283105
1 Switch, rocker, QPDT (12 lugs)	334042	1 Dial cord assembly	890026
1 Switch, rocker, TPTT (12 lugs)	334033	2 Lamp, dial, tubular	526008
1 Terminal strip, 4 screw	374004	1 Lamp, indicator, blue and white leads	526112
1 Terminal strip, 3 lug	373002	1 Lamp, indicator, blue and red leads	526012
1 Terminal strip, 4 lug	374006	2 Lamp cover, blue plastic	834022
1 Volume control with switch and attached fiber insulating washer	180203	1 Meter	508022
1 Wire, hookup, black	875001	1 Meter cover, black	711522
1 Wire, hookup, green		1 Pointer, dial	737022
1 Wire, hookup, red		5 Pulley, white plastic	894022
1 Wire, heavy #16 gauge, 6"		3 Pulley support, brass	733122
1 Card, warranty		1 Resistor, 1/2 watt, 3.3 megohm (orange-orange-green)	112335
1 Manual, instruction		1 Resistor, 1/4 watt, 1.0 megohm (brown-black-green)	119105
		1 Resistor, 1/4 watt, 150,000 ohms (brown-green-yellow)	119154
		1 Resistor, 1/2 watt, 470 ohms (yellow-violet-brown)	113471
		1 Sleeving, insulating	893001
		1 Spring, dial cord	712260
		1 Tuning shaft assembly	733022

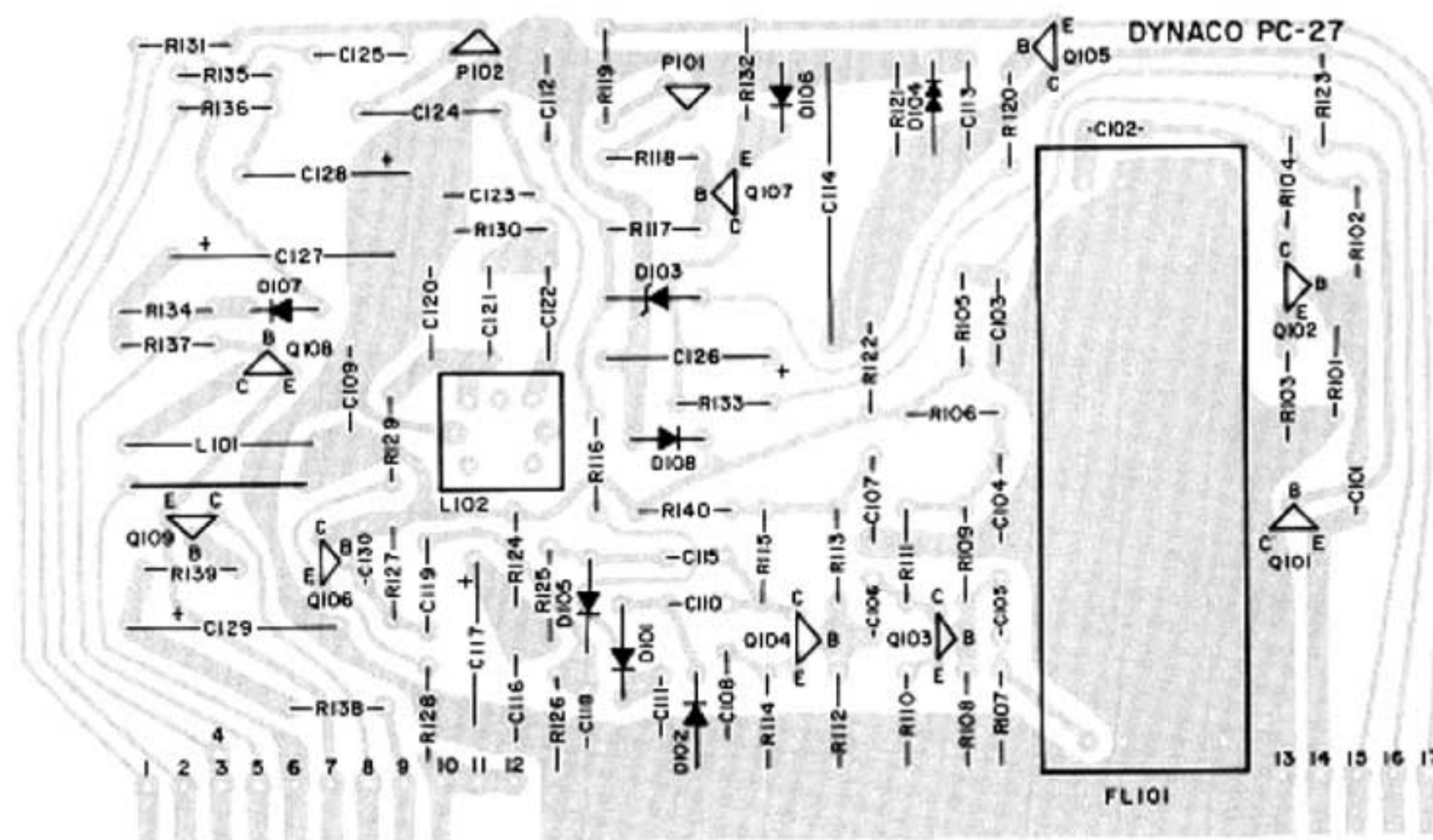
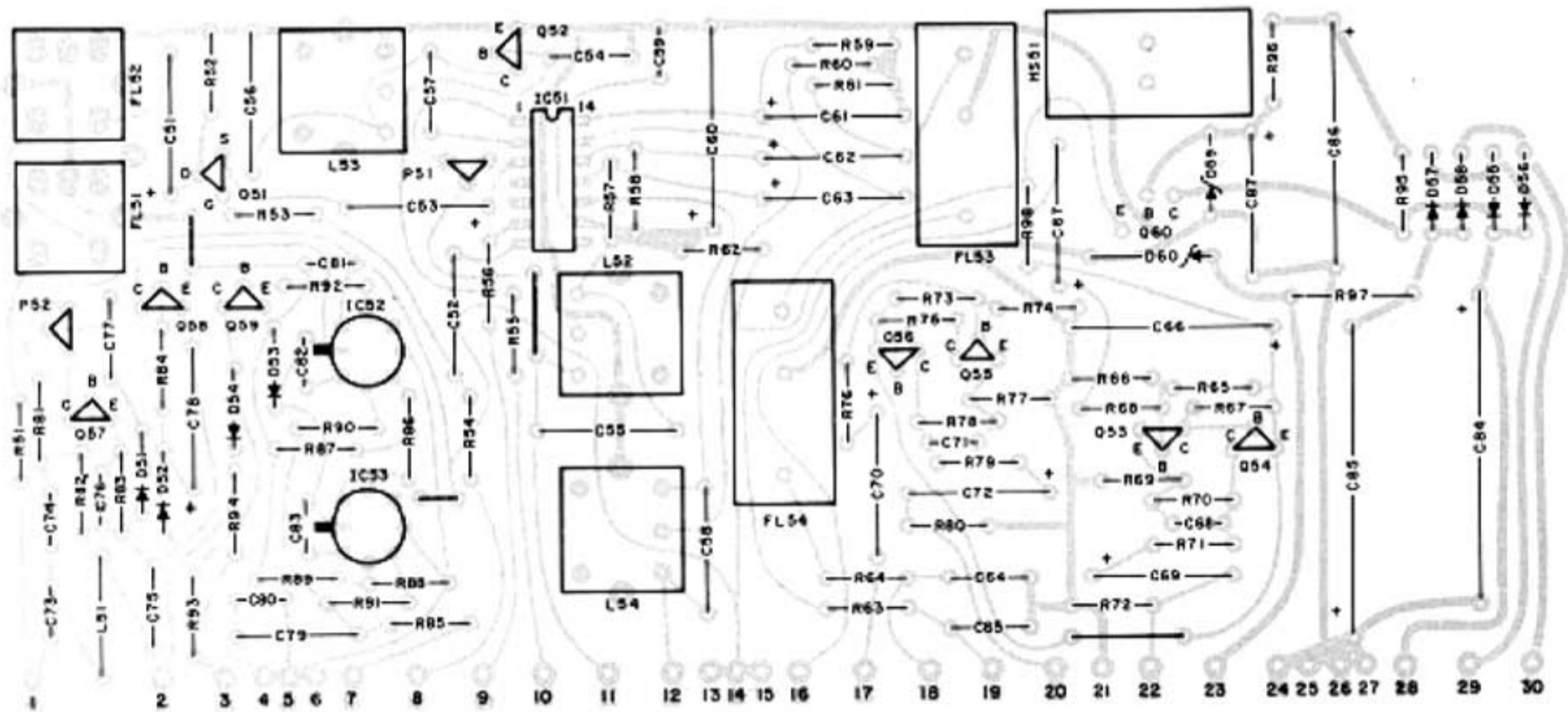
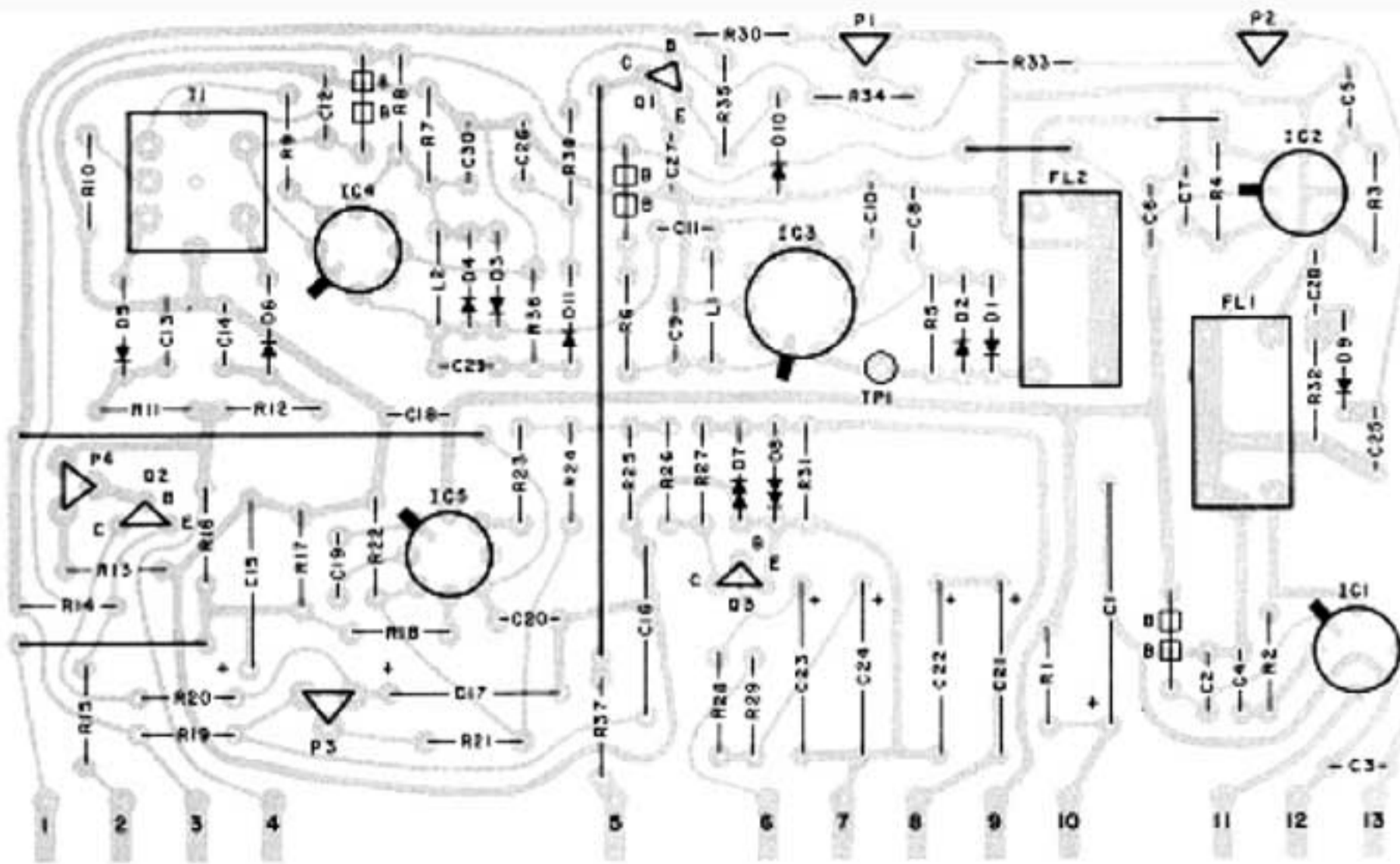

THIS VIEW IS OF THE CIRCUIT SIDE OF BOARD



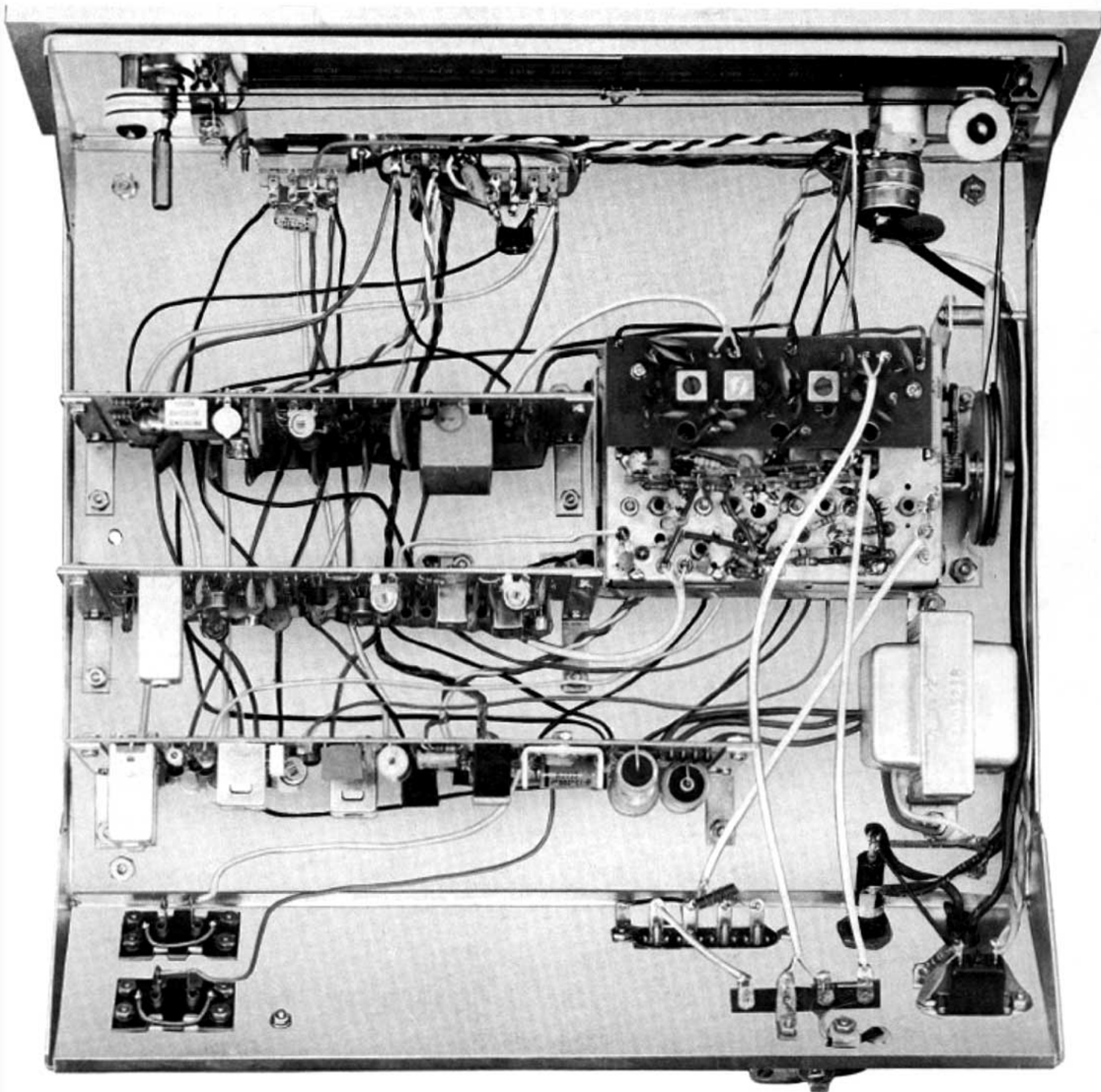

Printed in U.S.A.

Bob01605@aol.com